

OAL.: 110

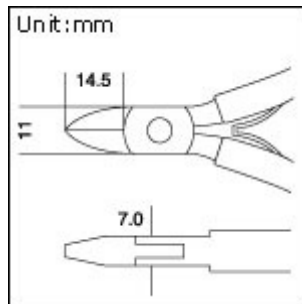

Material	HRC	Application	Weight (g)	Individual Packing
		Hard steel: 0.8mm		
AISI420	45±3	Soft steel: 1.3mm	79	Blister Card
		Copper: 2.0mm		