



TWO-WIRE ELECTRIC LOCK MULTI-UNIT DOOR PHONE

**DA-2DS/DA-4DS**  
**DA-2DG/DA-4DG**



Two-Wire Door Phone  
& Electric Strike for  
up to 4 Tenants

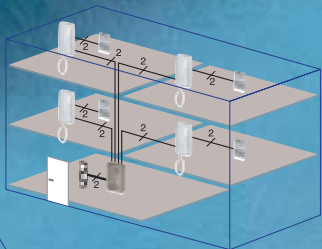

# DA Door Phone to Accommodate up to Four Residences

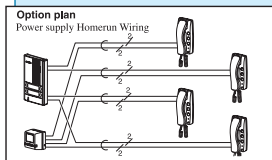
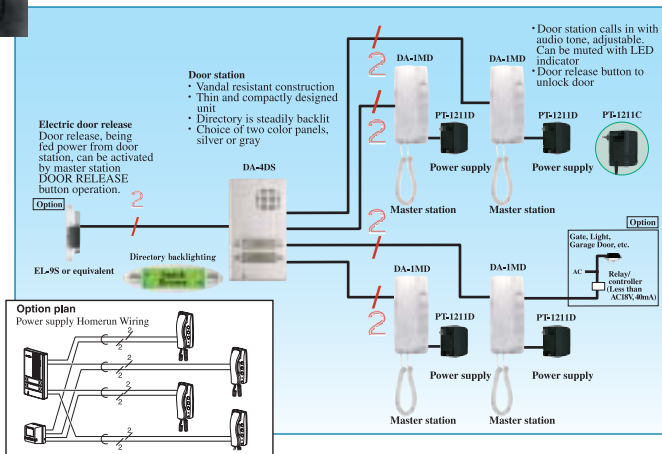

## Names & Dimensions

### • Master station

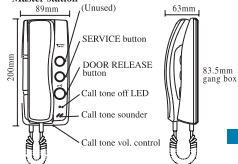

### • Door station

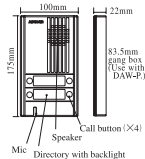

### • Power supply

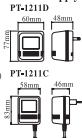

## System features

- Connect Electric Door Release with same two wires from Door station. Requires no extra power supply for door release.
- Existing doorbell or chime wires can be utilized (Disconnect from transformer)
- Master station is equipped with DOOR RELEASE and one FUNCTION button to turn on entrance light, etc.
- Optional call extension sounder

## Specifications

- Power source: AC 15V, supplied from Power supply
- Calling: Electronic tone(while the button is depressed) w/adj. volume or muted
- Communication: Simultaneous with handset
- Talk path: Single talk channel, with no break-in
- Weight: DA-1MD: approx. 370g. DA-4DS: approx. 270g. PT-1211C: 400g. PT-1211D: 430g.
- Wiring: 2 wires, polarized from door to ea. DA-1MD
- Wiring distance:

(1) Door Release (2) Door station (3) Master station (4) Power supply

	φ 0.6mm	φ 0.8mm	φ 1.0mm
(1)-(2)-(3)-(4)	110m	200m	310m
(3)-(4)	55m	100m	155m

- PT-1211C or D power supply is designed for exclusive use of DA-1MD.

DA-2DS DA-2DG



DA-4DG

## Options

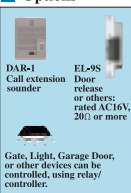

Distributed by:

**AIPHONE**<sup>®</sup>  
Providing Peace of Mind

<http://www.aiphone.com/>  
Printed in Japan