

Full HD Multiple Streams Compact Fixed Dome IP Camera

User's Manual

Ver 1.6

Table of Contents

1. Overview	2
1.1 Features	2
1.2 Package Contents	3
1.3 Dimensions	4
1.4 Installation (For Rugged Camera)	5
1.5 Connectors	6
2. Camera Cabling	7
2.1 Connect Ethernet Cable	7
2.1.1 Indoor Camera	7
2.1.2 Rugged Camera	8
3. System Requirements	9
4. Access Camera	10
5. Setup Video Resolution	13
6. Configuration Files Export/ Import	14
Appendix A: Technical Specifications	15
Appendix B: Delete the Existing DC Viewer	16
Appendix C: Setup Internet Security	17
Appendix D: Video Resolution	18
2M- Quad Streams	18
2M- Triple Streams	22
2M- Dual Streams	24
2M- Single Stream	24
2M Real time- Quad Streams	25
2M Real time- Triple Streams	29
2M Real time- Dual Streams	31
2M Real time- Single Stream	32

1. Overview

The Full HD Multiple Streams Compact Fixed Dome IP Camera is capable of serving real-time streaming and makes image quality more smoothly. In addition to MJPEG real time streaming, this camera develops H.264 codec to apply for high resolution digital broadcast.

With compact and sophisticated mechanical design, the Full HD Multiple Streams Compact Fixed Dome IP Camera is easy installed and aesthetic.







1.1 Features

- Progressive Scan CMOS Sensor
- Quad Streams Compression: H.264 Baseline/ Main/ High Profile + MJPEG
- Multi-language Support
- Tampering Alarm
- Wide Dynamic Range
- Motion Detection
- Privacy Masks
- Smart Picture Quality/ 3D Noise Reduction
- Vertical View Mode (Image rotation by 90 degrees)
- Network Failure Detection
- Weatherproof Dongle Cable*
- Weatherproof (IP66 international)*
- Micro SD support
- Security Torx against tampering
- ONVIF Support

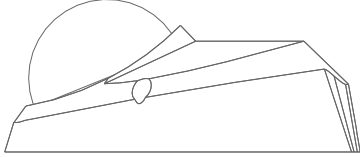
(*) Optional

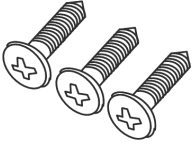
1.2 Package Contents

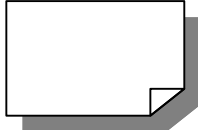
Please check the package contains the following items listed below.

 <p>Indoor Camera/ Rugged Camera (with Cable)</p>	 <p>Rubber Washer (x1, Casing) Rubber Washers (x3, Baseplate) (Rugged Camera only)</p>
 <p>Self-tapping screws (x3)</p>	 <p>Plastic Anchors (x3)</p>
 <p>Security Torx</p>	 <p>Quick Guide</p>
 <p>CD</p>	



NOTE: The type of the supplied self-tapping screws is mainly for softer substrate/material installation such as wood. For other installation environment such as cement wall, it is required to pre-drill and use plastic anchors before fastening the supplied self-tapping screw on the wall.

1.3 Dimensions

The IP Camera's dimensions are shown below.

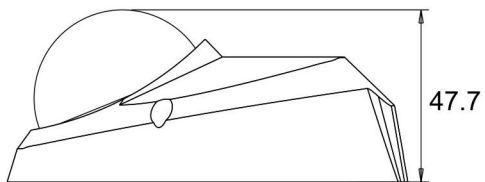
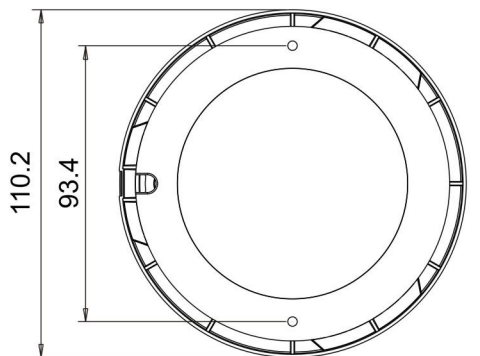

Unit: [mm]

1.4 Installation (For Rugged Camera)

For Rugged Camera, we suggest you to install the Camera as the following steps to make sure the Camera is well waterproof.

Step 1:

Put the Rubber Washers in both sides of the holes on the Bottom Plate of the Camera.

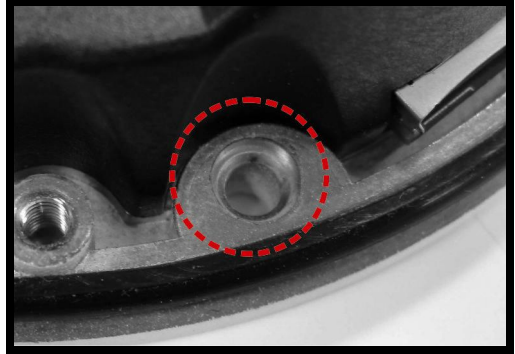

Step 2:

Aim the installing hole to the target installing position and fasten the screws to attach the Camera to the ceiling.



Step 3:

Refer to [1.5 Connectors](#) and [2. Camera Cabling](#) to connect the cable and adjust the lens.

Step 4:

Aim the arch parts on both Dome Cover and Bottom Plate to attach two parts firmly together. And then fasten the security screws on the Dome Cover to finish installing the Camera.



1.5 Connectors

The diagram below shows the IP Dome Camera's reset button and various adjusting screws. Definition for each will be given as follows.



Designation		Description
1	Reset Button	Restore to default setting; press the button with a proper tool
2	Lens	Rotate the lens right/left to adjust focus
3	Focus Fixed Screw	Loosen the screw to adjust the lens
4	Tilt Fixed Screw	Loosen the screw to adjust tilt angle
5	Micro SD Card Slot	For video recording storage

2. Camera Cabling

Please follow the instructions below to complete IP Camera connection.

2.1 Connect Ethernet Cable

Please follow the instructions below to connect Indoor/Rugged IP Dome Camera's Ethernet cable.

2.1.1 Indoor Camera

The Ethernet connector, which is located in the rear of the camera, is shown below:

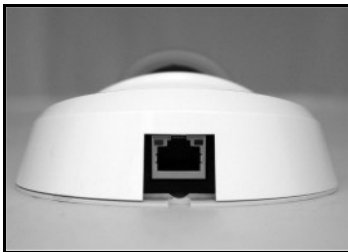

PoE Connection

Connect the one end of the Ethernet cable to the network port on the camera, and the other end to Power Sourcing Equipment (PSE) like hubs or routers. Check the status of the link indicator and activity indicator LEDs; if the LEDs are unlit, please check the connections.

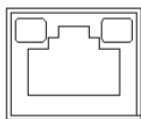

Green Link Light indicates good network connection.
Orange Activity Light flashes for network activity indication.

RJ-45 Lite Cable Connection



RJ-45 Lite Connector

- **RJ-45 Lite Cable Connection**

Connect one end of the Ethernet cable to the RJ-45 Lite Connector. Then connect the other end of the Ethernet cable to Power Sourcing Equipment (PSE) like hubs or routers.

2.1.2 Rugged Camera

The Rugged IP Dome Camera supports RJ-45 Dongle Cable.

RJ-45 Dongle Cable Connection



RJ-45 Dongle

- **RJ-45 Dongle Cable Connection**

Run the Ethernet cable through the Waterproof RJ-45 Screw-On Plug. Then connect one end of the Ethernet cable to the RJ-45 dongle, tightening the sealing nut of the Waterproof RJ-45 Screw-On Plug completely. Later on connect the other end of the Ethernet cable to Power Sourcing Equipment (PSE) like hubs or routers.



NOTE: Please use a PoE waterproof switch/hub so that the camera can work.

3. System Requirements

To perform the IP Camera via web browser, please ensure your PC is in good network connection, and meet system requirements as described below.

Items	System Requirement
Personal Computer	1. Intel® Pentium® M, 2.16 GHz or Intel® Core™ 2 Duo, 2.0 GHz 2. 2 GB RAM or more
Operating System	Windows VISTA/ Windows XP/ Windows 7
Web Browser	Microsoft Internet Explorer 6.0 or later Firefox Chrome Safari
Network Card	10Base-T (10 Mbps) or 100Base-TX (100 Mbps) operation
Viewer	ActiveX control plug-in for Microsoft IE

4. Access Camera

For initial access to the IP Camera, users can search the camera through the installer program: DeviceSearch.exe, which can be found in “DeviceSearch” folder in the supplied CD.

Device Search Software Setup

Step 1: Double click on the program Device Search.exe. After its window appears, click on the <Device Search> button on the top side.

Step 2: The security alert window will pop up. Click on <Unblock> to continue.

Device Search

Step 3: Click on <Device Search> again, and all the finding IP devices will be listed in the page. The IP Camera’s default IP address is: **192.168.0.250**.

Step 4: Double click or right click and select <Browse> to access the camera directly via web browser.

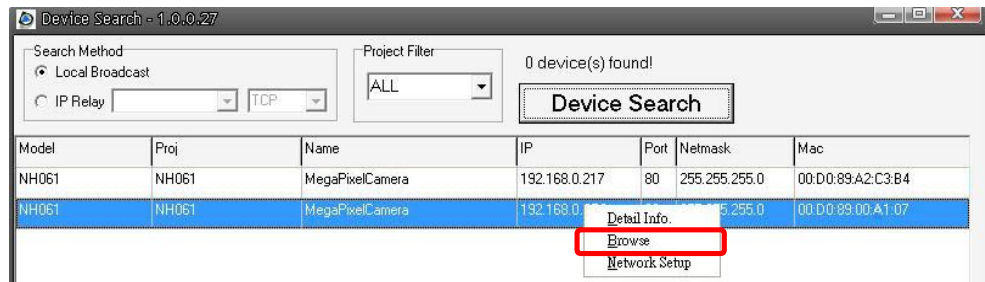

Step 5: Then the prompt window of request for entering default username and password will appear for logging in to the IP Camera.

The default login ID and password for the Administrator are:

Login ID	Password
Admin	1234



NOTE: ID and password are case sensitive.



NOTE: It is strongly advised that administrator’s password be altered for the security concerns. Refer to [Full HD Multiple Streams IP Camera Menu Tree](#) for further details.

Additionally, users can change the IP Camera's network property, either DHCP or Static IP, directly in the device finding list. Refer to the following section for changing the IP Camera's network property.

Example of Changing IP Camera's Network Property

Users can directly change an IP Camera's network property, ex. from static IP to DHCP, in the finding device list. The way to change the IP Camera's network property is specified below:

Step 1: In the finding device list, click on the IP Camera that you would like to change its network property. On the selected item, right click and select "Network Setup." Meanwhile, record the IP Camera's MAC address, for future identification.

Step 2: The "Network Setup" page will come out. Select "DHCP," and press "Apply" button down the page.

Step 3: Click on <OK> on the Note of setting change. Wait for one minute to re-search the IP Camera.

Step 4: Click on the <Device Search> button to search all the devices. Then select the IP Camera with the correct MAC address. Double click on the IP Camera, and the login window will come out.

Step 5: Enter User name and Password to access the IP Camera.

Installing DC Viewer Software Online

For the initial access to the IP Camera, a client program, DC Viewer, will be automatically installed to your PC when connecting to the IP Camera.

If the Web browser doesn't allow DC Viewer installation, please check the Internet security settings or ActiveX controls and plug-ins settings (refer to [Section: Setup Internet Security](#)) to continue the process.

The Information Bar (just below the URL bar) may come out and ask for permission to install the ActiveX Control for displaying video in browser. Right click on the Information Bar and select <Install ActiveX Control...> to allow the installation.

The download procedure of DC Viewer software is specified as follows.

Step 1: In the DC Viewer installation window, click on <Next> to start installation.

Step 2: The status bar will show the installation progress. After the installation is completed, click on <Finish> to exit the installation process.

Step 3: Click on <Finish> to close the DC Viewer installation page.

Once the DC Viewer is successfully installed, the IP Camera's Home page will be able to correctly display as the figure below.

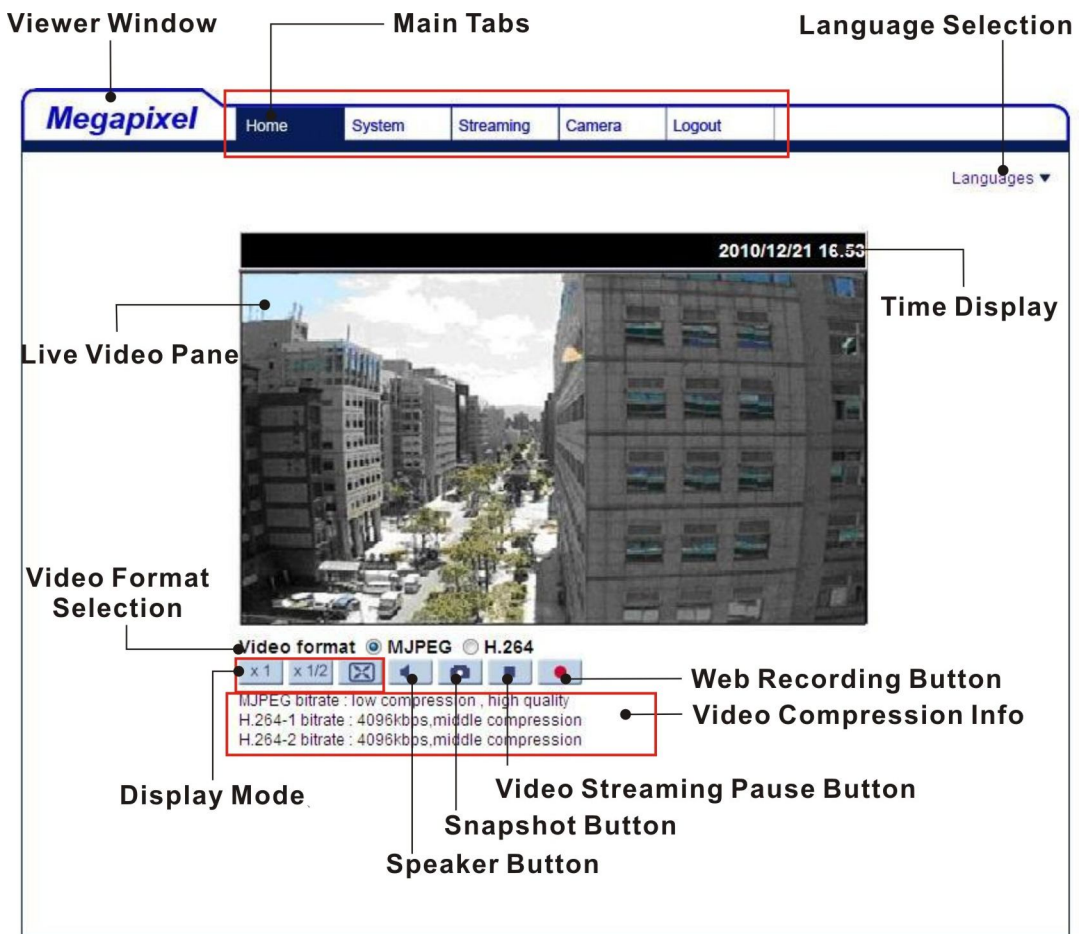

Image and Focus Adjustment

The image displays on the Home page when successfully accessing to the IP Camera. Adjust zoom and focus as necessary to produce a clear image.



Note: Please refer to [Full HD Multiple Streams IP Camera Menu Tree](#) for more button function detail.

5. Setup Video Resolution

Users can setup Video Resolution on Video Format page of the user-friendly browser-based configuration interface.

Video Format can be found under this path: **Streaming> Video Format**.

The screenshot shows the Megapixel configuration interface. The top navigation bar includes 'Home', 'System', 'Streaming', 'Camera', and 'Logout'. The 'Streaming' menu is highlighted in red. On the left sidebar, the 'Video Format' menu item is highlighted in red. The main content area is titled 'Video Format' and contains the following sections:

- Video Resolution :** A dropdown menu shows 'H.264 + H.264 + H.264 + H.264'. Below it are four H.264 format settings:
 - H.264-1 format : 1920 x 1080 (15 fps)
 - H.264-2 format : 1280 x 1024 (15 fps)
 - H.264-3 format : 1280 x 720 (15 fps)
 - H.264-4 format : 720 x 480 (15 fps)
- Note :** Image attachment by FTP or E-mail will be available only while MJPEG streaming is selected.
- Text Overlay Settings :** Includes checkboxes for 'Include date', 'Include time', and 'Include text string' with an input field. A 'Save' button is below.
- Video Rotate Type :** A dropdown menu set to 'Normal video'. A 'Save' button is below.
- GOV Settings :** Includes input fields for GOV Length for each format:
 - H.264-1 GOV Length : 60
 - H.264-2 GOV Length : 60
 - H.264-3 GOV Length : 30
 - H.264-4 GOV Length : 30
- H.264 Profile :** Includes dropdown menus for profile selection for each format, all set to 'Main profile'. A 'Save' button is below.

The default value of Video Resolution is as below:

2M	H.264- 1920 x 1080 (15 fps) + H.264- 1280 x 720 (30 fps)
2M Real time	H.264- 1920 x 1080 (30 fps) + H.264 720 x 480 (30 fps)

For more Video Resolution combination detail, please refer to [Appendix: Video Resolution](#). Click on <Save> to confirm the setting.

6. Configuration Files Export/ Import

To export/ import configuration files, users can access the Maintenance page on the user-friendly browser-based configuration interface.

The Maintenance setting can be found under this path: **System> Maintenance**.

Users can export configuration files to a specified location and retrieve data by uploading an existing configuration file to the IP Camera.

Export

Users can save the system settings by exporting the configuration file (.bin) to a specified location for future use. Click on the <Export> button, and the popup File Download window will come out. Click on <Save> and specify a desired location for saving the configuration file.

Upload

To copy an existing configuration file to the IP Camera, please first click on <Browse> to select the configuration file, and then click on the <Upload> button for uploading.

Appendix A: Technical Specifications

Camera		2M	2M Real-time
Image Sensor		1/2.7" Progressive CMOS	
Effective Pixels		1920(H) x 1080(V)	
Minimum Illumination		0.1 lux (Color)	
White Balance		Manual / AWB / ATW	
Shutter Speed		1~ 1/10000 sec.	
Lens			
Focal Length		4.0 mm	
F Number		F 1.5	
FOV		78°	
Operation			
Multiple Languages		English / French / German / Italian / Korean / Simplified Chinese / Traditional Chinese / Russian	
Image Setting	Backlight Compensation	On / Off	
	White Balance	Auto / Manual	
	Noise Reduction (3D)	On / Off	
	Wide Dynamic Range	On / Off	
	Privacy Mask	On / Off	
	Brightness	Manual	
	Exposure	Auto / Manual	
	Sharpness	Manual	
	Contrast	Manual	
	Saturation	Manual	
	Hue	Manual	
	Digital Zoom	Support	
	Motion Detection	On / Off	
	Privacy Mask Type	Color	
Audio	One-way Audio*	Mic in	
	Compression	G.711 / G.726	
Network			
Interface		RJ-45, 10/100 Mbps Ethernet	
Video Compression		H.264 / MJPEG	
Video Streaming		Dual Streams- H.264 + H.264 / MJPEG Quad Streams- H.264 + H.264 + H.264 + H.264/ MJPEG	
Video Resolution		H.264- Full HD 1080P / SXGA / HD 720P / XGA / SVGA / D1 / VGA / CIF MJPEG- Full HD 1080P / SXGA / HD 720P / XGA / SVGA / D1 / VGA / CIF	
Protocol		IPv4/v6, TCP/IP, UDP, RTP, RTSP, HTTP, HTTPS, ICMP, FTP, SMTP, DHCP, PPPoE, UPnP, IGMP, SNMP, QoS, ONVIF	
Security		HTTPS / IP Filter / IEEE 802.1X	
Event Notification		HTTP / FTP / SMTP	
Micro SD*		microSDHC 32GB support	
Supported Web Browser		Internet Explorer (6.0+) / Chrome / Firefox / Safari	
User Account		20	
Password Levels		User and Administrator	
Mechanical			
Lens Mounting		M12 Board Lens	
Connectors	Ethernet	RJ-45	
General			
Operating Temperature		-10°C ~ 50°C (14°F ~ 122°F)	
User and Administrator		10% ~ 90%, No Condensation	
Weatherproof Standard		Rugged Camera- IP66	
Dimension		∅ 110.2 x 47.7 mm (∅ 4.3 x 1.9 in.)	
Weight		180 g (0.40 lb)	
Power Source		PoE	
Power Consumption		3.5 W	
Regulatory		CE / FCC / RoHS	

(*) Optional

Appendix B: Delete the Existing DC Viewer

For users who have installed the DC Viewer in the PC previously, please first remove the existing DC Viewer from the PC before accessing to the IP Camera.

Deleting the DC Viewer

In the Windows <Start Menu>, activate <Control Panel>, and then double click on <Add or Remove Programs>. In the <Currently installed programs> list, select <DCViewer> and click on the button <Remove> to uninstall the existing DC Viewer.

Deleting Temporary Internet Files

To improve browser performance, it is suggested to clean up the all the files in the Temporary Internet Files.

The procedure is as follows:

Step 1: Click on the <Tools> tab on the menu bar and select <Internet Options>.

Step 2: Click on the <Delete> button under <Browsing history> section. Then click on the <Delete Files> button under the <Temporary Internet files> section.

Step 3: A confirmation window will pop up. Click on <Yes> to start deleting the files.

Appendix C: Setup Internet Security

If ActiveX control installation is blocked, please either set Internet security level to default or change ActiveX controls and plug-ins settings.

Internet Security Level: Default

Step 1: Start the Internet Explorer (IE).

Step 2: Click on the <Tools> tab on the menu bar and select <Internet Options>.

Step 3: Click on the <Security> tab, and select <Internet> zone.

Step 4: Down the page, click on the <Default Level> button and click on <OK> to confirm the setting. Close the browser window, and restart a new one later to access the IP Camera.

ActiveX Controls and Plug-ins Settings

Step 1: Repeat **Steps 1~3** of the previous section above.

Step 2: Down the page, click on the <Custom Level> button to change ActiveX controls and plug-ins settings. The Security Settings window will pop up.

Step 3: Under <ActiveX controls and plug-ins>, set **ALL** items (as listed below) to <Enable> or <Prompt>. Please note that the items vary by IE version.

ActiveX controls and plug-ins settings:

1. Allow previously unused ActiveX controls to run without prompt.
2. Allow Scriptlets.
3. Automatic prompting for ActiveX controls.
4. Binary and script behaviors.
5. Display video and animation on a webpage that does not use external media player.
6. Download signed ActiveX controls.
7. Download unsigned ActiveX controls.
8. Initialize and script ActiveX controls not marked as safe for scripting.
9. Run ActiveX controls and plug-ins.
10. Script ActiveX controls marked safe for scripting.

Step 4: Click on <OK> to accept the settings and close the Security Settings window.

Step 5: Click on <OK> to close the Internet Options screen.

Step 6: Close the browser window, and restart a new one later to access the IP Camera.

Appendix D: Video Resolution

2M- Quad Streams

H.264 + H.264 + H.264 + H.264 / MJPEG					
H.264-1	H.264-2	H.264-3	H.264-4 / MJPEG		
1920 x 1080 (15 fps)	1280 x 1024 (15 fps)	720 x 480 (15 fps)	352 x 240 (30 fps)		
		640 x 480 (15 fps)	352 x 240 (30 fps)		
		352 x 240 (30 fps)	352 x 240 (30 fps)		
	1280 x 720 (15 fps)	800 x 600 (15 fps)		720 x 480 (15 fps)	
				640 x 480 (15 fps)	
				352 x 240 (30 fps)	
		720 x 480 (15 fps)		720 x 480 (15 fps)	720 x 480 (15 fps)
				640 x 480 (15 fps)	640 x 480 (15 fps)
				720 x 480 (30 fps)	352 x 240 (30 fps)
				640 x 480 (15 fps)	640 x 480 (30 fps)
				640 x 480 (30 fps)	352 x 240 (30 fps)
	1024 x 768 (15 fps)	800 x 600 (15 fps)		720 x 480 (15 fps)	
				640 x 480 (15 fps)	
				352 x 240 (30 fps)	
		720 x 480 (15 fps)		720 x 480 (30 fps)	640 x 480 (30 fps)
				720 x 480 (30 fps)	352 x 240 (30 fps)
				640 x 480 (15 fps)	640 x 480 (30 fps)
	800 x 600 (15 fps)	800 x 600 (15 fps)		720 x 480 (30 fps)	
				640 x 480 (30 fps)	
				352 x 240 (30 fps)	
		720 x 480 (15 fps)		800 x 600 (30 fps)	352 x 240 (30 fps)
				720 x 480 (15 fps)	720 x 480 (30 fps)
				720 x 480 (30 fps)	640 x 480 (30 fps)
	800 x 600 (30 fps)	800 x 600 (30 fps)		640 x 480 (30 fps)	
				640 x 480 (30 fps)	
				352 x 240 (30 fps)	
	720 x 480 (15 fps)	720 x 480 (30 fps)		720 x 480 (30 fps)	
				640 x 480 (30 fps)	
				640 x 480 (30 fps)	
	720 x 480 (30 fps)	720 x 480 (30 fps)		352 x 240 (30 fps)	
			352 x 240 (30 fps)		
			352 x 240 (30 fps)		
640 x 480 (30 fps)	640 x 480 (30 fps)		640 x 480 (30 fps)		
			352 x 240 (30 fps)		
			352 x 240 (30 fps)		
352 x 240 (30 fps)	352 x 240 (30 fps)		352 x 240 (30 fps)		
			352 x 240 (30 fps)		

H.264 + H.264 + H.264 + H.264 / MJPEG				
H.264-1	H.264-2	H.264-3	H.264-4 / MJPEG	
1280 x 1024 (15 fps)	1280 x 1024 (15 fps)	1280 x 720 (15 fps)	720 x 480 (30 fps)	
			640 x 480 (30 fps)	
			352 x 240 (30 fps)	
		800 x 600 (15 fps)	800 x 600 (30 fps)	720 x 480 (30 fps)
				640 x 480 (30 fps)
				352 x 240 (30 fps)
		720 x 480 (15 fps)	720 x 480 (30 fps)	720 x 480 (30 fps)
	640 x 480 (30 fps)			
	352 x 240 (30 fps)			
	640 x 480 (30 fps)	640 x 480 (30 fps)	640 x 480 (30 fps)	
			352 x 240 (30 fps)	
			352 x 240 (30 fps)	
	1280 x 720 (15 fps)	1280 x 720 (15 fps)	1280 x 720 (15 fps)	720 x 480 (30 fps)
				640 x 480 (30 fps)
				352 x 240 (30 fps)
		800 x 600 (30 fps)	800 x 600 (30 fps)	720 x 480 (30 fps)
				640 x 480 (30 fps)
				352 x 240 (30 fps)
		720 x 480 (30 fps)	720 x 480 (30 fps)	720 x 480 (30 fps)
	640 x 480 (30 fps)			
	352 x 240 (30 fps)			
	640 x 480 (30 fps)	640 x 480 (30 fps)	640 x 480 (30 fps)	
			352 x 240 (30 fps)	
			352 x 240 (30 fps)	
	1280 x 720 (30 fps)	1280 x 720 (30 fps)	352 x 240 (30 fps)	352 x 240 (30 fps)
	1024 x 768 (15 fps)	800 x 600 (30 fps)	800 x 600 (30 fps)	720 x 480 (30 fps)
				640 x 480 (30 fps)
				352 x 240 (30 fps)
		720 x 480 (30 fps)	720 x 480 (30 fps)	720 x 480 (30 fps)
	640 x 480 (30 fps)			
	1024 x 768 (30 fps)	1024 x 768 (30 fps)	720 x 480 (30 fps)	
			640 x 480 (30 fps)	
			352 x 240 (30 fps)	
	800 x 600 (15 fps)	800 x 600 (15 fps)	800 x 600 (30 fps)	720 x 480 (30 fps)
	800 x 600 (30 fps)	800 x 600 (30 fps)	800 x 600 (30 fps)	640 x 480 (30 fps)
				352 x 240 (30 fps)
720 x 480 (30 fps)				
720 x 480 (30 fps)		720 x 480 (30 fps)	640 x 480 (30 fps)	
			352 x 240 (30 fps)	
			640 x 480 (30 fps)	
720 x 480 (30 fps)	720 x 480 (30 fps)	720 x 480 (30 fps)		
		640 x 480 (30 fps)		
	640 x 480 (30 fps)	640 x 480 (30 fps)	640 x 480 (30 fps)	
			352 x 240 (30 fps)	
640 x 480 (30 fps)	640 x 480 (30 fps)	640 x 480 (30 fps)		
		352 x 240 (30 fps)		
		640 x 480 (30 fps)		
		352 x 240 (30 fps)		
1280 x 1024 (30 fps)	800 x 600 (30 fps)	352 x 240 (30 fps)	352 x 240 (30 fps)	
	720 x 480 (30 fps)	352 x 240 (30 fps)	352 x 240 (30 fps)	
	640 x 480 (30 fps)	352 x 240 (30 fps)	352 x 240 (30 fps)	
	352 x 240 (30 fps)	352 x 240 (30 fps)	352 x 240 (30 fps)	

H.264 + H.264 + H.264 + H.264 / MJPEG					
H.264-1	H.264-2	H.264-3	H.264-4 / MJPEG		
1280 x 720 (15 fps)	1280 x 720 (15 fps)	1280 x 720 (15 fps)	720 x 480 (30 fps) 640 x 480 (30 fps)		
		1280 x 720 (30 fps)	352 x 240 (30 fps)		
		800 x 600 (30 fps)	720 x 480 (30 fps) 640 x 480 (30 fps)		
		720 x 480 (30 fps)	720 x 480 (30 fps) 640 x 480 (30 fps)		
		640 x 480 (30 fps)	640 x 480 (30 fps)		
	1280 x 720 (30 fps)	1280 x 720 (30 fps)	800 x 600 (30 fps)	352 x 240 (30 fps)	
			720 x 480 (30 fps)	352 x 240 (30 fps)	
			640 x 480 (30 fps)	352 x 240 (30 fps)	
			352 x 240 (30 fps)	352 x 240 (30 fps)	
	1024 x 768 (15 fps)	1024 x 768 (15 fps)	800 x 600 (30 fps)	720 x 480 (30 fps) 640 x 480 (30 fps)	
	1024 x 768 (30 fps)	1024 x 768 (30 fps)	800 x 600 (30 fps)	352 x 240 (30 fps)	
			720 x 480 (30 fps)	720 x 480 (30 fps) 640 x 480 (30 fps) 352 x 240 (30 fps)	
			640 x 480 (30 fps)	640 x 480 (30 fps) 352 x 240 (30 fps)	
		800 x 600 (30 fps)	800 x 600 (30 fps)	800 x 600 (30 fps)	720 x 480 (30 fps) 640 x 480 (30 fps) 352 x 240 (30 fps)
				720 x 480 (30 fps)	720 x 480 (30 fps) 640 x 480 (30 fps)
				640 x 480 (30 fps)	640 x 480 (30 fps)
	1280 x 720 (30 fps)	1024 x 768 (30 fps)	352 x 240 (30 fps)	352 x 240 (30 fps)	
		800 x 600 (30 fps)	800 x 600 (30 fps)	720 x 480 (30 fps) 352 x 240 (30 fps)	
			720 x 480 (30 fps)	640 x 480 (30 fps) 352 x 240 (30 fps)	
640 x 480 (30 fps)			640 x 480 (30 fps) 352 x 240 (30 fps)		
720 x 480 (30 fps)		720 x 480 (30 fps)	720 x 480 (30 fps)	640 x 480 (30 fps) 352 x 240 (30 fps)	
			640 x 480 (30 fps)	640 x 480 (30 fps) 352 x 240 (30 fps)	
			352 x 240 (30 fps)	352 x 240 (30 fps)	
640 x 480 (30 fps)		640 x 480 (30 fps)	640 x 480 (30 fps)	640 x 480 (30 fps) 352 x 240 (30 fps)	
			352 x 240 (30 fps)	352 x 240 (30 fps)	
352 x 240 (30 fps)		352 x 240 (30 fps)	352 x 240 (30 fps)	352 x 240 (30 fps)	
1024 x 768 (15 fps)	1024 x 768 (15 fps)	800 x 600 (30 fps)	720 x 480 (30 fps) 640 x 480 (30 fps)		
	1024 x 768 (30 fps)	800 x 600 (30 fps)	352 x 240 (30 fps)		
		720 x 480 (30 fps)	720 x 480 (30 fps) 640 x 480 (30 fps) 352 x 240 (30 fps)		
		640 x 480 (30 fps)	640 x 480 (30 fps)		
	800 x 600 (30 fps)	800 x 600 (30 fps)	800 x 600 (30 fps)	720 x 480 (30 fps) 640 x 480 (30 fps)	

2M- Triple Streams

H.264-1 + H.264-2 + H.264-3 / MJPEG		
H.264-1	H.264-2	H.264-3 / MJPEG
1920 x 1080 (15 fps)	1280 x 1024 (15 fps)	800 x 600 (15 fps)
		720 x 480 (15 fps)
		640 x 480 (15 fps)
		352 x 240 (30 fps)
	1280 x 720 (15 fps)	1280 x 720 (15 fps)
		800 x 600 (15 fps)
		720 x 480 (30 fps)
		640 x 480 (30 fps)
		352 x 240 (30 fps)
	1024 x 768 (15 fps)	800 x 600 (30 fps)
		720 x 480 (30 fps)
	1024 x 768 (30 fps)	640 x 480 (30 fps)
	800 x 600 (15 fps)	352 x 240 (30 fps)
	800 x 600 (30 fps)	800 x 600 (30 fps)
720 x 480 (30 fps)	720 x 480 (30 fps)	
	640 x 480 (30 fps)	
	352 x 240 (30 fps)	
640 x 480 (30 fps)	640 x 480 (30 fps)	
352 x 240 (30fps)	352 x 240 (30fps)	
1280 x 1024 (15 fps)	1280 x 1024 (15 fps)	1280 x 720 (15 fps)
		800 x 600 (30 fps)
		720 x 480 (30 fps)
		640 x 480 (30 fps)
		352 x 240 (30 fps)
	1280 x 720 (15 fps)	1280 x 720 (15 fps)
		800 x 600 (30 fps)
	1280 x 720 (30 fps)	720 x 480 (30 fps)
		640 x 480 (30 fps)
		352 x 240 (30 fps)
	1024 x 768 (30 fps)	800 x 600 (30 fps)
		720 x 480 (30 fps)
		640 x 480 (30 fps)
		352 x 240 (30 fps)
800 x 600 (30 fps)	800 x 600 (30 fps)	
	720 x 480 (30 fps)	
	640 x 480 (30 fps)	
720 x 480 (30 fps)	720 x 480 (30 fps)	
800 x 600 (30 fps)	352 x 240 (30 fps)	
1280 x 1024 (30 fps)	720 x 480 (30 fps)	
	640 x 480 (30 fps)	
	352 x 240 (30 fps)	
	640 x 480 (30 fps)	
	352 x 240 (30 fps)	
1280 x 720 (15 fps)	1280 x 720 (15 fps)	
	1280 x 720 (30 fps)	
	800 x 600 (30 fps)	
	720 x 480 (30 fps)	
	640 x 480 (30 fps)	
	1024 x 768 (30 fps)	
		800 x 600 (30 fps)
		720 x 480 (30 fps)
		640 x 480 (30 fps)
		800 x 600 (30 fps)
		720 x 480 (30 fps)
		640 x 480 (30 fps)

H.264-1 + H.264-2 + H.264-3 / MJPEG			
H.264-1	H.264-2	H.264-3 / MJPEG	
1280 x 720 (30 fps)	1280 x 720 (30 fps)	352 x 240 (30 fps)	
	1024 x 768 (30 fps)	352 x 240 (30 fps)	
	800 x 600 (30 fps)	800 x 600 (30 fps)	800 x 600 (30 fps)
			720 x 480 (30 fps)
			640 x 480 (30 fps)
			352 x 240 (30 fps)
	720 x 480 (30 fps)	720 x 480 (30 fps)	720 x 480 (30 fps)
			640 x 480 (30 fps)
352 x 240 (30 fps)			
640 x 480 (30 fps)	640 x 480 (30 fps)	640 x 480 (30 fps)	
352 x 240 (30 fps)	352 x 240 (30 fps)	352 x 240 (30 fps)	
1024 x 768 (15 fps)	1024 x 768 (30 fps)	800 x 600 (30 fps)	
1024 x 768 (30 fps)	1024 x 768 (30 fps)	720 x 480 (30 fps)	
		640 x 480 (30 fps)	
		352 x 240 (30 fps)	
	800 x 600 (30 fps)	800 x 600 (30 fps)	800 x 600 (30 fps)
			720 x 480 (30 fps)
			640 x 480 (30 fps)
			352 x 240 (30 fps)
	720 x 480 (30 fps)	720 x 480 (30 fps)	720 x 480 (30 fps)
			640 x 480 (30 fps)
			352 x 240 (30 fps)
	640 x 480 (30 fps)	640 x 480 (30 fps)	640 x 480 (30 fps)
			352 x 240 (30 fps)
352 x 240 (30 fps)	352 x 240 (30 fps)	352 x 240 (30 fps)	
800 x 600 (30 fps)	800 x 600 (30 fps)	800 x 600 (30 fps)	
		720 x 480 (30 fps)	
		640 x 480 (30 fps)	
		352 x 240 (30 fps)	
	720 x 480 (30 fps)	720 x 480 (30 fps)	720 x 480 (30 fps)
			640 x 480 (30 fps)
			352 x 240 (30 fps)
	640 x 480 (30 fps)	640 x 480 (30 fps)	640 x 480 (30 fps)
352 x 240 (30 fps)			
352 x 240 (30 fps)	352 x 240 (30 fps)	352 x 240 (30 fps)	
720 x 480 (30 fps)	720 x 480 (30 fps)	720 x 480 (30 fps)	
		640 x 480 (30 fps)	
		352 x 240 (30 fps)	
	640 x 480 (30 fps)	640 x 480 (30 fps)	640 x 480 (30 fps)
640 x 480 (30 fps)	640 x 480 (30 fps)	352 x 240 (30 fps)	
		352 x 240 (30 fps)	
		352 x 240 (30 fps)	
352 x 240 (30 fps)	352 x 240 (30 fps)	352 x 240 (30 fps)	

2M- Dual Streams

H.264-1 + H.264-2 / MJPEG		
H.264-1	H.264-2 / MJPEG	BNC SUPPORT
1920 x 1080 (15 fps)	1280 x 1024 (15 fps)	-
	1280 x 720 (30 fps)	-
	1024 x 768 (30 fps)	-
	800 x 600 (30 fps)	-
	720 x 480 (30 fps)	√
	640 x 480 (30 fps)	√
	352 x 240 (30 fps)	√
1280 x 1024 (30 fps)	1280 x 1024 (15 fps)	√
	1280 x 720 (15 fps)	-
	1024 x 768 (15 fps)	-
	800 x 600 (30 fps)	-
	720 x 480 (30 fps)	√
	640 x 480 (30 fps)	√
	352 x 240 (30 fps)	√
1280 x 720 (30 fps)	1280 x 720 (30 fps)	√
	1024 x 768 (30 fps)	-
	800 x 600 (30 fps)	-
	720 x 480 (30 fps)	√
	640 x 480 (30 fps)	√
	352 x 240 (30 fps)	√
1024 x 768 (30 fps)	1024 x 768 (30 fps)	√
	800 x 600 (30 fps)	-
	720 x 480 (30 fps)	√
	640 x 480 (30 fps)	√
	352 x 240 (30 fps)	√
800 x 600 (30 fps)	800 x 600 (30 fps)	√
	720 x 480 (30 fps)	√
	640 x 480 (30 fps)	√
	352 x 240 (30 fps)	√
720 x 480 (30 fps)	720 x 480 (30 fps)	√
	640 x 480 (30 fps)	√
	352 x 240 (30 fps)	√
640 x 480 (30 fps)	640 x 480 (30 fps)	√
	352 x 240 (30 fps)	√
352 x 240 (30 fps)	352 x 240 (30 fps)	-

2M- Single Stream

H.264 Only	BNC SUPPORT
1920 x 1080 (15 fps) Low Latency	-
1920 x 1080 (15 fps)	√
1280 x 1024 (30 fps)	√
1280 x 720 (30 fps)	√
1024 x 768 (30 fps)	√
800 x 600 (30 fps)	√
720 x 480 (30 fps)	√
640 x 480 (30 fps)	√
352 x 240 (30 fps)	-

MJPEG Only	BNC SUPPORT
1920 x 1080 (15 fps)	√
1280 x 1024 (30 fps)	√
1280 x 720 (30 fps)	√
1024 x 768 (30 fps)	√
800 x 600 (30 fps)	√
720 x 480 (30 fps)	√
640 x 480 (30 fps)	√
352 x 240 (30 fps)	-

2M Real time- Quad Streams

H.264 + H.264 + H.264 + H.264 / MJPEG					
H.264-1	H.264-2	H.264-3	H.264-4 / MJPEG		
1920 x 1080 (15 fps)	1280 x 1024 (15 fps)	1280 x 720 (15 fps)	720 x 480 (15 fps)		
			640 x 480 (15 fps)		
		352 x 240 (30 fps)			
		800 x 600 (15 fps)	720 x 480 (30 fps)		
			640 x 480 (30 fps)		
		800 x 600 (30 fps)	352 x 240 (30 fps)		
		720 x 480 (15 fps)	720 x 480 (30 fps)		
		720 x 480 (30 fps)	640 x 480 (30 fps)		
		352 x 240 (30 fps)			
		640 x 480 (30 fps)	640 x 480 (30 fps)		
		352 x 240 (30 fps)	352 x 240 (30 fps)		
		352 x 240 (30 fps)	352 x 240 (30 fps)		
	1280 x 720 (15 fps)	1280 x 720 (15 fps)	800 x 600 (30 fps)	720 x 480 (30 fps)	
				640 x 480 (30 fps)	
		352 x 240 (30 fps)			
		720 x 480 (30 fps)	720 x 480 (30 fps)		
			640 x 480 (30 fps)		
		640 x 480 (30 fps)	640 x 480 (30 fps)		
		640 x 480 (30 fps)	640 x 480 (30 fps)		
		1280 x 720 (30 fps)	720 x 480 (30 fps)	352 x 240 (30 fps)	
	640 x 480 (30 fps)		352 x 240 (30 fps)		
	352 x 240 (30 fps)		352 x 240 (30 fps)		
	1024 x 768 (15 fps)	800 x 600 (30 fps)	720 x 480 (30 fps)	720 x 480 (30 fps)	
				640 x 480 (30 fps)	
		720 x 480 (30 fps)	720 x 480 (30 fps)		
		640 x 480 (30 fps)	640 x 480 (30 fps)		
	1024 x 768 (30 fps)	800 x 600 (30 fps)	352 x 240 (30 fps)		
		720 x 480 (30 fps)	352 x 240 (30 fps)		
		640 x 480 (30 fps)	352 x 240 (30 fps)		
		352 x 240 (30 fps)	352 x 240 (30 fps)		
	800 x 600 (30 fps)	800 x 600 (30 fps)	720 x 480 (30 fps)	720 x 480 (30 fps)	
				640 x 480 (30 fps)	
				352 x 240 (30 fps)	
		720 x 480 (30 fps)	720 x 480 (30 fps)	640 x 480 (30 fps)	640 x 480 (30 fps)
					352 x 240 (30 fps)
					352 x 240 (30 fps)
		640 x 480 (30 fps)	640 x 480 (30 fps)	352 x 240 (30 fps)	640 x 480 (30 fps)
					352 x 240 (30 fps)
	720 x 480 (30 fps)	720 x 480 (30 fps)	640 x 480 (30 fps)	720 x 480 (30 fps)	
				352 x 240 (30 fps)	
		640 x 480 (30 fps)	640 x 480 (30 fps)	352 x 240 (30 fps)	640 x 480 (30 fps)
					352 x 240 (30 fps)
640 x 480 (30 fps)	640 x 480 (30 fps)	352 x 240 (30 fps)	640 x 480 (30 fps)		
			352 x 240 (30 fps)		
1920 x 1080 (30 fps)	352 x 240 (30 fps)	352 x 240 (30 fps)	352 x 240 (30 fps)		

H.264 + H.264 + H.264 + H.264 / MJPEG				
H.264-1	H.264-2	H.264-3	H.264-4 / MJPEG	
1280 x 1024 (15 fps)	1280 x 1024 (15 fps)	1280 x 720 (15 fps)	720 x 480 (30 fps) 640 x 480 (30 fps)	
		1280 x 720 (30 fps)	352 x 240 (30 fps)	
		800 x 600 (30 fps)	720 x 480 (30 fps)	720 x 480 (30 fps)
			640 x 480 (30 fps)	640 x 480 (30 fps)
			352 x 240 (30 fps)	352 x 240 (30 fps)
		720 x 480 (30 fps)	720 x 480 (30 fps)	720 x 480 (30 fps)
	640 x 480 (30 fps)		640 x 480 (30 fps)	
	1280 x 1024 (30 fps)	1280 x 1024 (30 fps)	720 x 480 (30 fps)	352 x 240 (30 fps)
			640 x 480 (30 fps)	352 x 240 (30 fps)
			352 x 240 (30 fps)	352 x 240 (30 fps)
	1280 x 720 (15 fps)	1280 x 720 (30 fps)	720 x 480 (30 fps)	720 x 480 (30 fps)
			640 x 480 (30 fps)	640 x 480 (30 fps)
			352 x 240 (30 fps)	352 x 240 (30 fps)
	1280 x 720 (30 fps)	800 x 600 (30 fps)	800 x 600 (30 fps)	720 x 480 (30 fps) 640 x 480 (30 fps) 352 x 240 (30 fps)
			720 x 480 (30 fps)	720 x 480 (30 fps)
			640 x 480 (30 fps)	640 x 480 (30 fps)
		640 x 480 (30 fps)	640 x 480 (30 fps)	640 x 480 (30 fps)
			352 x 240 (30 fps)	352 x 240 (30 fps)
			352 x 240 (30 fps)	352 x 240 (30 fps)
	1024 x 768 (30 fps)	800 x 600 (30 fps)	800 x 600 (30 fps)	720 x 480 (30 fps) 640 x 480 (30 fps) 352 x 240 (30 fps)
			720 x 480 (30 fps)	720 x 480 (30 fps)
			640 x 480 (30 fps)	640 x 480 (30 fps)
		640 x 480 (30 fps)	640 x 480 (30 fps)	640 x 480 (30 fps)
			352 x 240 (30 fps)	352 x 240 (30 fps)
352 x 240 (30 fps)			352 x 240 (30 fps)	
1280 x 1024 (15 fps)	800 x 600 (30 fps)	800 x 600 (30 fps)	720 x 480 (30 fps) 640 x 480 (30 fps)	
		720 x 480 (30 fps)	720 x 480 (30 fps)	
		640 x 480 (30 fps)	640 x 480 (30 fps)	
1280 x 1024 (30 fps)	1024 x 768 (30 fps)	352 x 240 (30 fps)	352 x 240 (30 fps)	
	800 x 600 (30 fps)	800 x 600 (30 fps)	352 x 240 (30 fps)	
		720 x 480 (30 fps)	352 x 240 (30 fps)	
		640 x 480 (30 fps)	640 x 480 (30 fps)	
		352 x 240 (30 fps)	352 x 240 (30 fps)	
	720 x 480 (30 fps)	720 x 480 (30 fps)	720 x 480 (30 fps)	720 x 480 (30 fps)
			640 x 480 (30 fps)	640 x 480 (30 fps)
			352 x 240 (30 fps)	352 x 240 (30 fps)
			352 x 240 (30 fps)	352 x 240 (30 fps)
	640 x 480 (30 fps)	640 x 480 (30 fps)	640 x 480 (30 fps)	640 x 480 (30 fps)
			352 x 240 (30 fps)	352 x 240 (30 fps)
			352 x 240 (30 fps)	352 x 240 (30 fps)
	352 x 240 (30 fps)	352 x 240 (30 fps)	352 x 240 (30 fps)	352 x 240 (30 fps)

H.264 + H.264 + H.264 + H.264 / MJPEG				
H.264-1	H.264-2	H.264-3	H.264-4 / MJPEG	
1280 x 720 (15 fps)	1280 x 720 (15 fps)	1280 x 720 (30 fps)	720 x 480 (30 fps) 640 x 480 (30 fps)	
	1280 x 720 (30 fps)	1280 x 720 (30 fps)	352 x 240 (30 fps)	
		800 x 600 (30 fps)	720 x 480 (30 fps) 640 x 480 (30 fps)	
		720 x 480 (30 fps)	720 x 480 (30 fps) 640 x 480 (30 fps)	
		640 x 480 (30 fps)	640 x 480 (30 fps)	
	1024 x 768 (30 fps)	800 x 600 (30 fps)	720 x 480 (30 fps) 640 x 480 (30 fps)	
	1280 x 720 (30 fps)	1280 x 720 (30 fps)	800 x 600 (30 fps)	352 x 240 (30 fps)
720 x 480 (30 fps)			352 x 240 (30 fps)	
640 x 480 (30 fps)			352 x 240 (30 fps)	
352 x 240 (30 fps)			352 x 240 (30 fps)	
1024 x 768 (30 fps)		800 x 600 (30 fps)	352 x 240 (30 fps)	
		720 x 480 (30 fps)	720 x 480 (30 fps) 640 x 480 (30 fps) 352 x 240 (30 fps)	
		640 x 480 (30 fps)	640 x 480 (30 fps) 352 x 240 (30 fps)	
		352 x 240 (30 fps)	352 x 240 (30 fps)	
		800 x 600 (30 fps)	800 x 600 (30 fps)	720 x 480 (30 fps) 640 x 480 (30 fps) 352 x 240 (30 fps)
720 x 480 (30 fps)			720 x 480 (30 fps) 640 x 480 (30 fps) 352 x 240 (30 fps)	
640 x 480 (30 fps)			640 x 480 (30 fps) 352 x 240 (30 fps)	
352 x 240 (30 fps)			352 x 240 (30 fps)	
720 x 480 (30 fps)			720 x 480 (30 fps)	720 x 480 (30 fps) 640 x 480 (30 fps) 352 x 240 (30 fps)
			640 x 480 (30 fps)	640 x 480 (30 fps) 352 x 240 (30 fps)
		352 x 240 (30 fps)	352 x 240 (30 fps)	
640 x 480 (30 fps)		640 x 480 (30 fps)	640 x 480 (30 fps) 352 x 240 (30 fps)	
		352 x 240 (30 fps)	352 x 240 (30 fps)	
352 x 240 (30 fps)		352 x 240 (30 fps)	352 x 240 (30 fps)	

2M Real time- Triple Streams

H.264-1 + H.264-2 + H.264-3 / MJPEG			
H.264-1	H.264-2	H.264-3 / MJPEG	
1920 x 1080 (15 fps)	1280 x 1024 (15 fps)	1280 x 720 (15 fps)	
		800 x 600 (30 fps)	
		720 x 480 (30 fps)	
		640 x 480 (30 fps)	
	1280 x 720 (15 fps)	1280 x 720 (30 fps)	1280 x 720 (30 fps)
			800 x 600 (30 fps)
	1280 x 720 (30 fps)	1280 x 720 (30 fps)	720 x 480 (30 fps)
			640 x 480 (30 fps)
			352 x 240 (30 fps)
	1024 x 768 (30 fps)	1024 x 768 (30 fps)	800 x 600 (30 fps)
			720 x 480 (30 fps)
			640 x 480 (30 fps)
			352 x 240 (30 fps)
	800 x 600 (30 fps)	800 x 600 (30 fps)	800 x 600 (30 fps)
720 x 480 (30 fps)			
640 x 480 (30 fps)			
352 x 240 (30 fps)			
720 x 480 (30 fps)	720 x 480 (30 fps)	720 x 480 (30 fps)	
		640 x 480 (30 fps)	
		352 x 240 (30 fps)	
640 x 480 (30 fps)	640 x 480 (30 fps)	640 x 480 (30 fps)	
		352 x 240 (30 fps)	
1920 x 1080 (30 fps)	352 x 240 (30 fps)	352 x 240 (30 fps)	
1280 x 1024 (15 fps)	1280 x 1024 (15 fps)	1280 x 720 (30 fps)	
		800 x 600 (30 fps)	
	1280 x 1024 (30 fps)	1280 x 1024 (30 fps)	720 x 480 (30 fps)
			640 x 480 (30 fps)
			352 x 240 (30 fps)
	1280 x 720 (15 fps)	1280 x 720 (15 fps)	1280 x 720 (30 fps)
			800 x 600 (30 fps)
1280 x 720 (30 fps)	1280 x 720 (30 fps)	720 x 480 (30 fps)	
		640 x 480 (30 fps)	
1024 x 768 (30 fps)	1024 x 768 (30 fps)	800 x 600 (30 fps)	
		720 x 480 (30 fps)	
1280 x 1024 (30 fps)	1280 x 720 (30 fps)	352 x 240 (30 fps)	
		640 x 480 (30 fps)	
	1024 x 768 (30 fps)	1024 x 768 (30 fps)	352 x 240 (30 fps)
			800 x 600 (30 fps)
			720 x 480 (30 fps)
	800 x 600 (30 fps)	800 x 600 (30 fps)	720 x 480 (30 fps)
			640 x 480 (30 fps)
			352 x 240 (30 fps)
			720 x 480 (30 fps)
	720 x 480 (30 fps)	720 x 480 (30 fps)	640 x 480 (30 fps)
352 x 240 (30 fps)			
640 x 480 (30 fps)			
640 x 480 (30 fps)	640 x 480 (30 fps)	352 x 240 (30 fps)	
		352 x 240 (30 fps)	
352 x 240 (30 fps)	352 x 240 (30 fps)	352 x 240 (30 fps)	
		352 x 240 (30 fps)	
1280 x 720 (15 fps)	1280 x 720 (30 fps)	1280 x 720 (30 fps)	

H.264-1 + H.264-2 + H.264-3 / MJPEG			
H.264-1	H.264-2	H.264-3 / MJPEG	
1280 x 720 (30 fps)	1280 x 720 (30 fps)	800 x 600 (30 fps)	
		720 x 480 (30 fps)	
		640 x 480 (30 fps)	
		352 x 240 (30 fps)	
	1024 x 768 (30 fps)	1024 x 768 (30 fps)	800 x 600 (30 fps)
			720 x 480 (30 fps)
			640 x 480 (30 fps)
			352 x 240 (30 fps)
	800 x 600 (30 fps)	800 x 600 (30 fps)	800 x 600 (30 fps)
			720 x 480 (30 fps)
			640 x 480 (30 fps)
			352 x 240 (30 fps)
	720 x 480 (30 fps)	720 x 480 (30 fps)	720 x 480 (30 fps)
			640 x 480 (30 fps)
352 x 240 (30 fps)			
640 x 480 (30 fps)	640 x 480 (30 fps)	640 x 480 (30 fps)	
		352 x 240 (30 fps)	
352 x 240 (30 fps)	352 x 240 (30 fps)	352 x 240 (30 fps)	
1024 x 768 (30 fps)	1024 x 768 (30 fps)	800 x 600 (30 fps)	
		720 x 480 (30 fps)	
		640 x 480 (30 fps)	
		352 x 240 (30 fps)	
	800 x 600 (30 fps)	800 x 600 (30 fps)	800 x 600 (30 fps)
			720 x 480 (30 fps)
			640 x 480 (30 fps)
	720 x 480 (30 fps)	720 x 480 (30 fps)	720 x 480 (30 fps)
			640 x 480 (30 fps)
			352 x 240 (30 fps)
640 x 480 (30 fps)	640 x 480 (30 fps)	640 x 480 (30 fps)	
		352 x 240 (30 fps)	
352 x 240 (30 fps)	352 x 240 (30 fps)	352 x 240 (30 fps)	
800 x 600 (30 fps)	800 x 600 (30 fps)	800 x 600 (30 fps)	
		720 x 480 (30 fps)	
		640 x 480 (30 fps)	
		352 x 240 (30 fps)	
	720 x 480 (30 fps)	720 x 480 (30 fps)	720 x 480 (30 fps)
			640 x 480 (30 fps)
640 x 480 (30 fps)	640 x 480 (30 fps)	640 x 480 (30 fps)	
		352 x 240 (30 fps)	
352 x 240 (30 fps)	352 x 240 (30 fps)	352 x 240 (30 fps)	
720 x 480 (30 fps)	720 x 480 (30 fps)	720 x 480 (30 fps)	
		640 x 480 (30 fps)	
		352 x 240 (30 fps)	
	640 x 480 (30 fps)	640 x 480 (30 fps)	640 x 480 (30 fps)
352 x 240 (30 fps)			
640 x 480 (30 fps)	640 x 480 (30 fps)	640 x 480 (30 fps)	
		352 x 240 (30 fps)	
		352 x 240 (30 fps)	
352 x 240 (30 fps)	352 x 240 (30 fps)	352 x 240 (30 fps)	

2M Real time- Dual Streams

H.264-1 + H.264-2 / MJPEG		
H.264-1	H.264-2 / MJPEG	BNC SUPPORT
1920 x 1080 (15 fps)	1920 x 1080 (15 fps)	√
	1280 x 1024 (30 fps)	-
	1280 x 720 (30 fps)	-
	1024 x 768 (30 fps)	-
	800 x 600 (30 fps)	-
1920 x 1080 (30 fps)	720 x 480 (30 fps)	√
	640 x 480 (30 fps)	√
	352 x 240 (30 fps)	√
1280 x 1024 (30 fps)	1280 x 1024 (15 fps)	√
	1280 x 720 (30 fps)	-
	1024 x 768 (30 fps)	-
	800 x 600 (30 fps)	-
	720 x 480 (30 fps)	√
	640 x 480 (30 fps)	√
	352 x 240 (30 fps)	√
1280 x 720 (30 fps)	1280 x 720 (30 fps)	√
	1024 x 768 (30 fps)	-
	800 x 600 (30 fps)	-
	720 x 480 (30 fps)	√
	640 x 480 (30 fps)	√
	352 x 240 (30 fps)	√
1024 x 768 (30 fps)	1024 x 768 (30 fps)	√
	800 x 600 (30 fps)	-
	720 x 480 (30 fps)	√
	640 x 480 (30 fps)	√
	352 x 240 (30 fps)	√
800 x 600 (30 fps)	800 x 600 (30 fps)	√
	720 x 480 (30 fps)	√
	640 x 480 (30 fps)	√
	352 x 240 (30 fps)	√
720 x 480 (30 fps)	720 x 480 (30 fps)	√
	640 x 480 (30 fps)	√
	352 x 240 (30 fps)	√
640 x 480 (30 fps)	640 x 480 (30 fps)	√
	352 x 240 (30 fps)	√
352 x 240 (30 fps)	352 x 240 (30 fps)	-

2M Real time- Single Stream

H.264 Only	BNC SUPPORT
1920 x 1080 (30 fps) Low Latency*	-
1920 x 1080 (30 fps)	√
1280 x 1024 (30 fps)	√
1280 x 720 (30 fps)	√
1024 x 768 (30 fps)	√
800 x 600 (30 fps)	√
720 x 480 (30 fps)	√
640 x 480 (30 fps)	√
352 x 240 (30 fps)	-

*1920 x 1080 (30 fps) Low Latency does not support BNC, 3DNR and Motion Detection.

MJPEG Only	BNC SUPPORT
1920 x 1080 (30 fps)	√
1280 x 1024 (30 fps)	√
1280 x 720 (30 fps)	√
1024 x 768 (30 fps)	√
800 x 600 (30 fps)	√
720 x 480 (30 fps)	√
640 x 480 (30 fps)	√
352 x 240 (30 fps)	-