

# Full HD Multiple Streams Box IP Camera User's Manual

Ver1.5

# Table of Contents

|  |           |
|--|-----------|
| <b>1. Overview</b>                               | <b>2</b>  |
| 1.1 Features                                     | 2         |
| 1.2 Package Contents                             | 3         |
| 1.3 Dimensions                                   | 3         |
| 1.4 Connectors                                   | 4         |
| <b>2. Camera Cabling</b>                         | <b>5</b>  |
| 2.1 Connect Power                                | 5         |
| 2.2 Connect Ethernet Cable                       | 5         |
| 2.3 Lens Mounting                                | 6         |
| 2.4 Connect Alarm I/O                            | 6         |
| 2.5 Connect RS485 (for DC12V/AC24V/PoE Model)    | 6         |
| <b>3. System Requirements</b>                    | <b>7</b>  |
| <b>4. Access Camera</b>                          | <b>8</b>  |
| <b>5. Setup Video Resolution</b>                 | <b>11</b> |
| <b>6. Configuration File Export/ Import</b>      | <b>12</b> |
| <b>Appendix A: Technical Specifications</b>      | <b>13</b> |
| <b>Appendix B: Delete the Existing DC Viewer</b> | <b>17</b> |
| <b>Appendix C: Setup Internet Security</b>       | <b>18</b> |
| <b>Appendix D: Back Focus Adjustment</b>         | <b>19</b> |
| <b>Appendix D: Video Resolution</b>              | <b>20</b> |
| 2M- Quad Streams                                 | 20        |
| 2M- Triple Streams                               | 24        |
| 2M- Dual Streams                                 | 26        |
| 2M- Single Stream                                | 26        |
| 2M Real time / 3M / 5M- Quad Streams             | 27        |
| 2M Real time / 3M / 5M- Triple Streams           | 32        |
| 2M Real time / 3M / 5M- Dual Streams             | 35        |
| 2M Real time / 3M / 5M- Single Stream            | 36        |

# 1. Overview

Supported with both H.264 and MJPEG standard, the product series not only features in superior Full HD resolution for real-time streaming at 25/30 fps, but also supplies D1 Real-time streaming. With more computing power, the IP Camera could provide more flexibility for users and system managers.

## 1.1 Features

- Progressive Scan CMOS Sensor
- 2M / 3M / 5M Resolution\*
- C / CS Mount Lens
- Quad Streams support
- Dual Streams, Full HD 1080P real-time + D1 real-time
- Dual Streams Compression:  
H.264 Baseline / Main / High Profile + MJPEG
- Multi-language support
- Tampering Alarm
- Wide Dynamic Range
- Motion Detection
- Privacy Masks
- Smart Picture Quality / 3D Noise Reduction
- Vertical View Mode (Image rotation by 90 degrees)
- Smart IR Mode
- Network Failure Detection
- Day / Night (ICR)
- Auto Iris Lens support
- Micro SD support
- BNC Analog Output
- RS-485 support\*
- ONVIF Support

## 1.2 Package Contents

Please check the package contains the following items listed below.

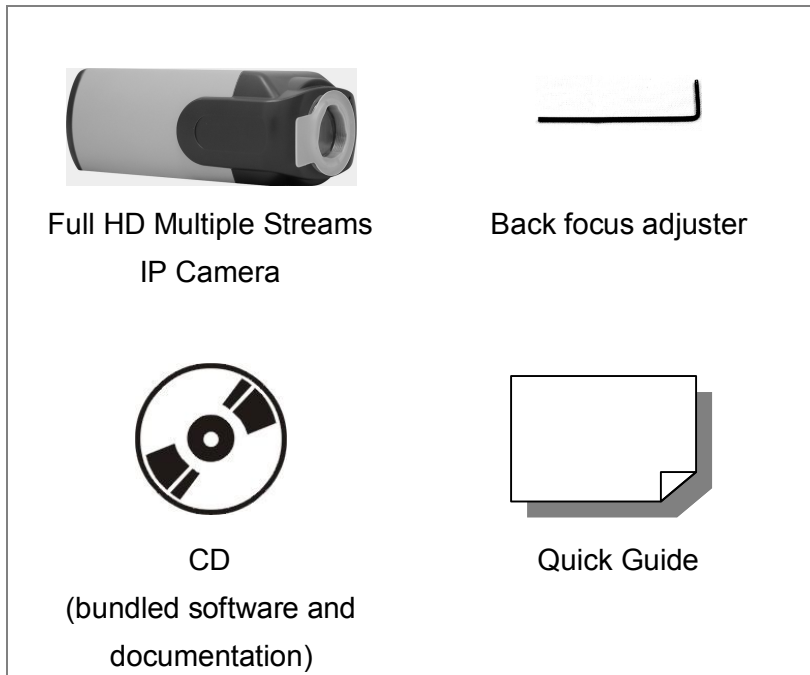

## 1.3 Dimensions

The IP Camera's dimensions are shown below.

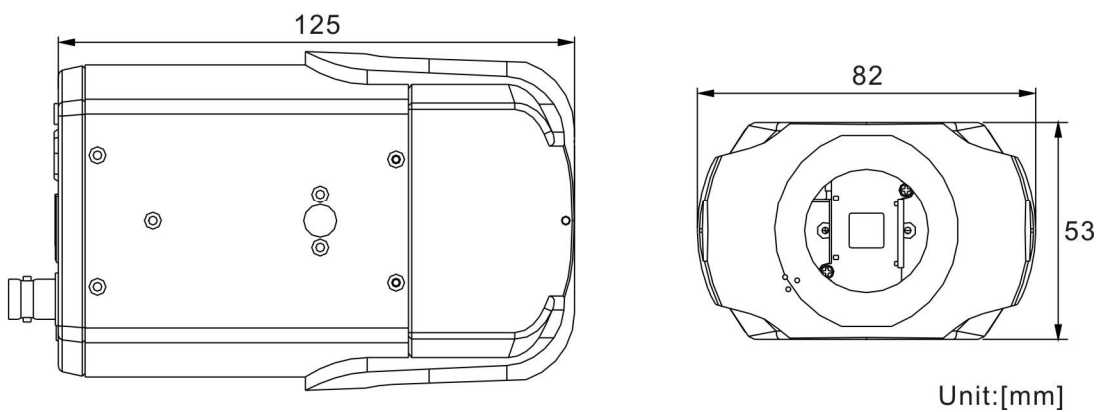

## 1.4 Connectors

The diagram below shows the IP Camera's reset button and various connectors. Definition for each connector will be given as follows.

### DC 12V/ PoE

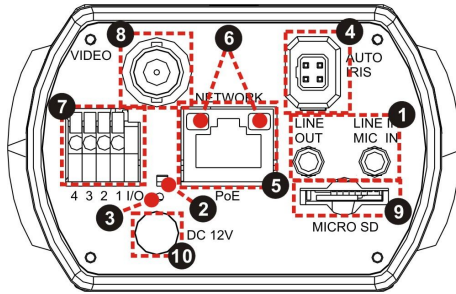

### DC 12V/ AC 24V/ PoE

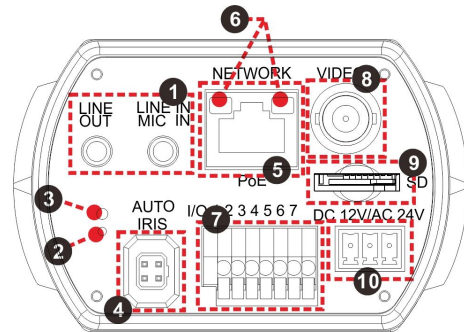

### C/CS Mount Lens

| No. | Definition                             | Remarks                                    |                  |
|-----|--|--|------------------|
| 1   | LINE OUT & LINE IN / MIC IN            | Two-way audio transmission                 |                  |
| 2   | Power LED                              | Power connection indication (green light)  |                  |
| 3   | Reset button                           | Reset to factory default                   |                  |
| 4   | AUTO IRIS connector                    | Auto iris lens connector                   |                  |
| 5   | NETWORK (with PoE)                     | RJ-45 connector                            |                  |
| 6   | Network LEDs                           | Network connection and activity indication |                  |
| 7   | Alarm I/O                              | 1 Output+                                  | 5 GND            |
|     |  | 2 Output-                                  | 6 D-             |
|     |  | 3 Input+                                   | 7 D+             |
|     |  | 4 Input-                                   |                  |
| 8   | VIDEO (BNC connector)                  | For video output                           |                  |
| 9   | Micro SD Card slot                     | For video recording storage                |                  |
| 10  | AC 24V/DC 12V connector (AC 24V Model) | + AC 24V: Power-1                          | DC 12V: Power    |
|     |  | ⏏ AC 24V: Earth GND                        | DC 12V: Reserved |
|     |  | - AC 24V: Power-2                          | DC 12V: GND      |

## 2. Camera Cabling

Please follow the instructions below to complete IP Camera installation.

### 2.1 Connect Power

Please refer to [Section: Connectors](#). Alternatively, connect the Ethernet cable to the camera's PoE port and plug the other end of the cable into a PoE switch.



**NOTE:** If using PoE, make sure Power Sourcing Equipment (PSE) is in use in the network.

### 2.2 Connect Ethernet Cable

Use of Category 5 Ethernet cable is recommended for network connection; to have best transmission quality, cable length shall not exceed 100 meters. Connect one end of the Ethernet cable to the RJ-45 connector of the IP Camera, and the other end of the cable to the network switch or PC.



**NOTE:** In some cases, you may need use an Ethernet crossover cable when connecting the IP Camera directly to the PC.

Check the status of the link indicator and activity indicator LEDs; if the LEDs are unlit, please check LAN connection.

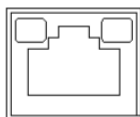

Green Link Light indicates good network connection.

Orange Activity Light flashes for network activity indication.

## 2.3 Lens Mounting

If use C-Mount lens, after removing the camera's plastic cover, users need to mount the C/CS mount adapter to the camera. Then attach the lens onto the C/CS mount adapter, as the illustrations shown below.

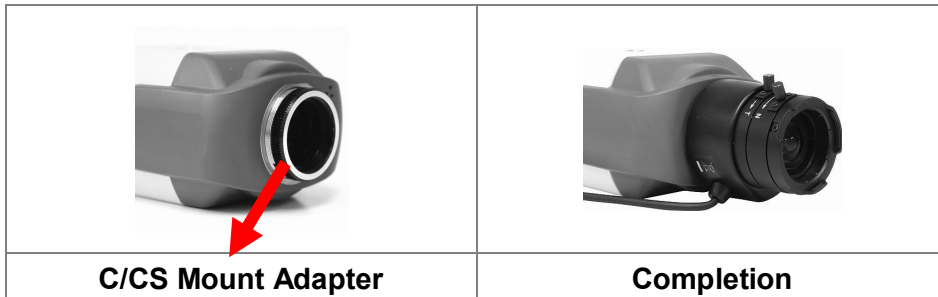

## 2.4 Connect Alarm I/O

The camera equips one alarm input and one relay output for alarm application. Refer to alarm pin definition below to connect alarm devices to the IP Camera if needed.

### DC 12V/ PoE

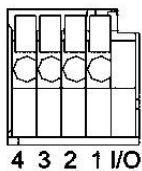

- PIN 1: Output+
- PIN 2: Output-
- PIN 3: Input+
- PIN 4: Input-

### DC 12V/ AC 24V/ PoE

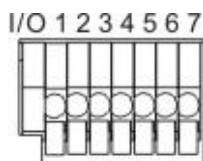

## 2.5 Connect RS485 (for DC12V/AC24V/PoE Model)

The RS-485 connector is the interface for connecting with the pan & tilt positioning system.

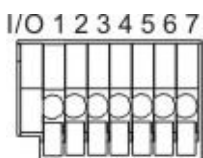

- PIN 6: D-
- PIN 7: D+

### 3. System Requirements

To perform the IP Camera via web browser, please ensure your PC is in good network connection, and meet system requirements as described below.

| Items                    | System Requirement   |
|--------------------------|--|
| <b>Personal Computer</b> | 1. Intel® Pentium® M, 2.16 GHz or<br>Intel® Core™2 Duo, 2.0 GHz<br>2. 2 GB RAM or more |
| <b>Operating System</b>  | Windows VISTA/ Windows XP/ Windows 7   |
| <b>Web Browser</b>       | Microsoft Internet Explorer 6.0 or later<br>Firefox<br>Chrome<br>Safari                |
| <b>Network Card</b>      | 10Base-T (10 Mbps) or 100Base-TX (100 Mbps) operation                                  |
| <b>Viewer</b>            | ActiveX control plug-in for Microsoft IE   |



## 4. Access Camera

For initial access to the IP Camera, users can search the camera through the installer program: DeviceSearch.exe, which can be found in “DeviceSearch” folder in the supplied CD.

### Device Search Software Setup

**Step 1:** Double click on the program Device Search.exe. After its window appears, click on the <Device Search> button on the top side.

**Step 2:** The security alert window will pop up. Click on <Unblock> to continue.

### Device Search

**Step 3:** Click on <Device Search> again, and all the finding IP devices will be listed in the page. The IP Camera’s default IP address is: **192.168.0.250**.

**Step 4:** Double click or right click and select <Browse> to access the camera directly via web browser.

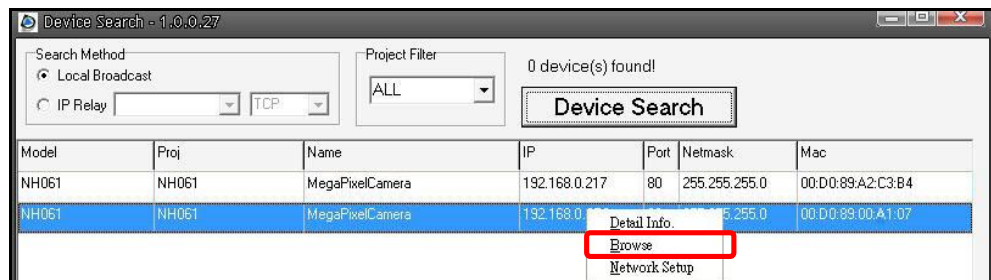

**Step 5:** Then the prompt window of request for entering default username and password will appear for logging in to the IP Camera.

The default login ID and password for the Administrator are:

| Login ID | Password |
|----------|----------|
| Admin    | 1234     |



**NOTE:** ID and password are case sensitive.



**NOTE:** It is strongly advised that administrator’s password be altered for the security concerns. Refer to [Full HD Multiple Streams IP Camera Menu Tree](#) for further details.

Additionally, users can change the IP Camera's network property, either DHCP or Static IP, directly in the device finding list. Refer to the following section for changing the IP Camera's network property.

### **Example of Changing IP Camera's Network Property**

Users can directly change an IP Camera's network property, ex. from static IP to DHCP, in the finding device list. The way to change the IP Camera's network property is specified below:

**Step 1:** In the finding device list, click on the IP Camera that you would like to change its network property. On the selected item, right click and select "Network Setup." Meanwhile, record the IP Camera's MAC address, for future identification.

**Step 2:** The "Network Setup" page will come out. Select "DHCP," and press "Apply" button down the page.

**Step 3:** Click on <OK> on the Note of setting change. Wait for one minute to re-search the IP Camera.

**Step 4:** Click on the <Device Search> button to search all the devices. Then select the IP Camera with the correct MAC address. Double click on the IP Camera, and the login window will come out.

**Step 5:** Enter User name and Password to access the IP Camera.

### **Installing DC Viewer Software Online**

For the initial access to the IP Camera, a client program, DC Viewer, will be automatically installed to your PC when connecting to the IP Camera.

If the Web browser doesn't allow DC Viewer installation, please check the Internet security settings or ActiveX controls and plug-ins settings (refer to [Section: Setup Internet Security](#)) to continue the process.

The Information Bar (just below the URL bar) may come out and ask for permission to install the ActiveX Control for displaying video in browser. Right click on the Information Bar and select <Install ActiveX Control...> to allow the installation.

The download procedure of DC Viewer software is specified as follows.

**Step 1:** In the DC Viewer installation window, click on <Next> to start installation.

**Step 2:** The status bar will show the installation progress. After the installation is completed, click on <Finish> to exit the installation process.

**Step 3:** Click on <Finish> to close the DC Viewer installation page.

Once the DC Viewer is successfully installed, the IP Camera's Home page will be able to correctly display as the figure below.

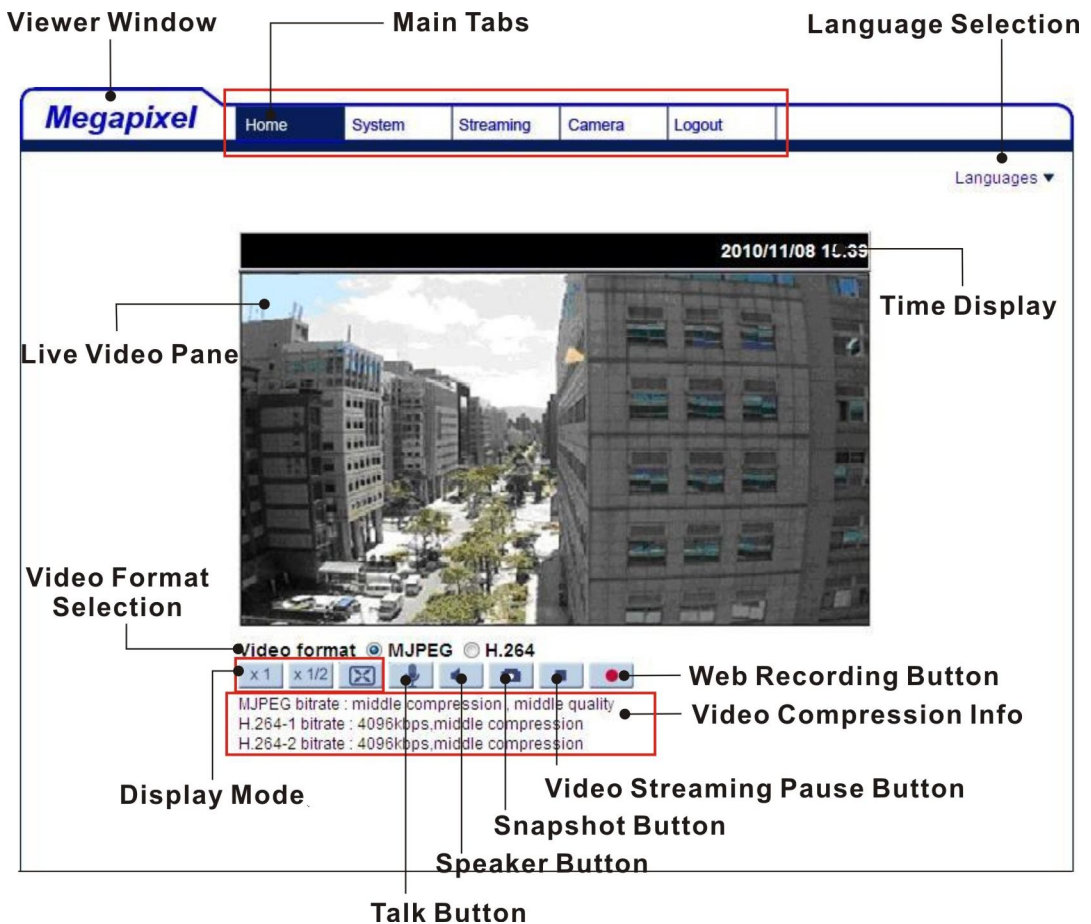

### **Image and Focus Adjustment**

The image displays on the Home page when successfully accessing to the IP Camera. Adjust zoom and focus as necessary to produce a clear image.



**Note:** Please refer to [Full HD Multiple Streams IP Camera Menu Tree](#) for more button function detail.

## 5. Setup Video Resolution

Users can setup Video Resolution on Video Format page of the user-friendly browser-based configuration interface.

Video Format can be found under this path: **Streaming> Video Format**.

The screenshot shows the Megapixel configuration interface. The top navigation bar includes 'Home', 'System', 'Streaming', 'Camera', and 'Logout'. The 'Streaming' menu item is highlighted with a red box. On the left sidebar, the 'Video Format' menu item is also highlighted with a red box. The main content area is titled 'Video Format' and contains the following sections:

- Video Resolution :** A dropdown menu showing 'H.264 + H.264 + H.264 + H.264'. Below it are four format options:
  - H.264-1 format : 1920 x 1080 (15 fps)
  - H.264-2 format : 1280 x 1024 (15 fps)
  - H.264-3 format : 1280 x 720 (15 fps)
  - H.264-4 format : 720 x 480 (15 fps)
 A 'Save' button is located below these options.
- Note :** Image attachment by FTP or E-mail will be available only while MJPEG streaming is selected.
- Text Overlay Settings :** Includes checkboxes for 'Include date', 'Include time', and 'Include text string' (with an input field). A 'Save' button is below.
- Video Rotate Type :** A dropdown menu set to 'Normal video'. A 'Save' button is below.
- GOV Settings :** Includes input fields for GOV Length for each format:
  - H.264-1 GOV Length : 60
  - H.264-2 GOV Length : 60
  - H.264-3 GOV Length : 30
  - H.264-4 GOV Length : 30
 A 'Save' button is below.
- H.264 Profile :** Includes dropdown menus for profile selection for each format:
  - H.264-1 : Main profile
  - H.264-2 : Main profile
  - H.264-3 : Main profile
  - H.264-4 : Main profile
 A 'Save' button is below.

The default value of Video Resolution is as below:

|                     |  |
|---------------------|--|
| <b>2M</b>           | H.264- 1920 x 1080 (15 fps) + H.264- 1280 x 720 (30 fps) |
| <b>2M Real time</b> |  |
| <b>3M</b>           | H.264- 1920 x 1080 (30 fps) + H.264 720 x 480 (30 fps)   |
| <b>5M</b>           |  |

For more Video Resolution combination detail, please refer to [Appendix: Video Resolution](#). Click on <Save> to confirm the setting.

## 6. Configuration File Export/ Import

To export/ import configuration files, users can access the Maintenance page on the user-friendly browser-based configuration interface.

The Maintenance setting can be found under this path: **System> Maintenance**.

Users can export configuration files to a specified location and retrieve data by uploading an existing configuration file to the IP Camera. It is especially convenient to make multiple cameras having the same configuration.

### **Export**

Users can save the system settings by exporting the configuration file (.bin) to a specified location for future use. Click on the <Export> button, and the popup File Download window will come out. Click on <Save> and specify a desired location for saving the configuration file.

### **Upload**

To copy an existing configuration file to the IP Camera, please first click on <Browse> to select the configuration file, and then click on the <Upload> button for uploading.

## Appendix A: Technical Specifications

| Camera                |                             | 2M   | 2M Real time |
|-----------------------|-----------------------------|--|--------------|
| Image Sensor          |                             | 1/2.7" Progressive CMOS  |              |
| Effective Pixels      |                             | 1920(H) x 1080(V)  |              |
| Minimum Illumination  |                             | 0.2 lux (Color)<br>0.02 lux (B/W)  |              |
| White Balance         |                             | Manual / AWB/ ATW  |              |
| Shutter Speed         |                             | 1~ 1/10000 sec.  |              |
| Lens                  |                             |  |              |
| Lens                  |                             | C / CS Mount   |              |
| Operation             |                             |  |              |
| Multiple Languages    |                             | English / French / German / Italian / Korean / Simplified Chinese /<br>Traditional Chinese / Russian                                       |              |
| Image Setting         | Backlight Compensation      | On / Off   |              |
|                       | White Balance               | Auto / Manual  |              |
|                       | Noise Reduction (3D)        | On / Off   |              |
|                       | Wide Dynamic Range          | On / Off   |              |
|                       | Privacy Mask                | On / Off   |              |
|                       | Brightness                  | Manual   |              |
|                       | Exposure                    | Auto / Manual  |              |
|                       | Sharpness                   | Manual   |              |
|                       | Contrast                    | Manual   |              |
|                       | Saturation                  | Manual   |              |
|                       | Hue                         | Manual   |              |
|                       | Digital Zoom                | Support  |              |
|                       | Motion Detection            | On / Off   |              |
|                       | Privacy Mask Type           | Color  |              |
|                       | ICR*                        | Auto / On / Off / Smart  |              |
| Tampering Alarm       | On / Off                    |  |              |
| Audio                 | Two-way Audio               | Line out, Line in / Mic in   |              |
|                       | Compression                 | G.711 / G.726  |              |
| Network               |                             |  |              |
| Interface             |                             | RJ-45, 10/100 Mbps Ethernet  |              |
| Video Compression     |                             | H.264 / MJPEG  |              |
| Video Streaming       |                             | Dual Streams- H.264 + H.264 / MJPEG<br>Quad Streams- H.264 + H.264 + H.264 + H.264/ MJPEG  |              |
| Video Resolution      |                             | H.264- Full HD 1080P / SXGA / HD 720P / XGA / SVGA / D1 / VGA / CIF<br>MJPEG- Full HD 1080P / SXGA / HD 720P / XGA / SVGA / D1 / VGA / CIF |              |
| Protocol              |                             | IPv4/v6, TCP/IP, UDP, RTP, RTSP, HTTP, HTTPS, ICMP, FTP, SMTP,<br>DHCP, PPPoE, UPnP, IGMP, SNMP, QoS, ONVIF                                |              |
| Security              |                             | HTTPS / IP Filter / IEEE 802.1x  |              |
| Alarm                 | Input                       | 1 Set<br>5V 10kΩ pull up   |              |
|                       | Output                      | 1 Set<br>Photo Relay Output 300V DC/AC   |              |
| Event Notification    |                             | HTTP / FTP / SMTP  |              |
| Micro SD              |                             | microSDHC 32GB support   |              |
| Supported Web Browser |                             | Internet Explorer (6.0+) / Chrome / Firefox / Safari   |              |
| User Account          |                             | 20   |              |
| Password Levels       |                             | User and Administrator   |              |
| Mechanical            |                             |  |              |
| Lens Mounting         |                             | C / CS Mount   |              |
| LED Indicator         |                             | Power / Link / ACT   |              |
| Connectors            | Auto Iris                   | DC Drive   |              |
|                       | Alarm                       | 4 Pin Terminal Block, Pitch 3.5 mm   |              |
|                       | Power                       | DC 12V / 3 Pin Terminal Block  |              |
|                       | Ethernet                    | RJ-45  |              |
|                       | Analog Video                | 1.0 Vp-p / 75 Ω, BNC   |              |
|                       | RS-485*                     | D+, D-   |              |
| Audio                 | Stereo Phone Jack, Ø 3.5 mm |  |              |

| <b>General</b>        |                                       |
|-----------------------|---------------------------------------|
| Operating Temperature | -10°C ~ 50°C (14°F ~ 122°F)           |
| Humidity              | 10% ~ 90%, No Condensation            |
| Dimension             | 125 x 82 x 52 mm (L x W x H) w/o Lens |
| Weight                | 330 g (0.73 lb)                       |
| Power Source          | DC 12V / PoE<br>DC 12V / AC 24V / PoE |
| Power Consumption     | 4W                                    |
| Regulatory            | CE / FCC / RoHS                       |

(\*) Optional

| Camera                |  | 3M   | 5M  |
|-----------------------|--|--|---|
| Image Sensor          |  | 3M Sony Progressive CMOS   | 5M Progressive CMOS                           |
| Effective Pixels      |  | 2048(H) x 1536(V)  | 2592(H) x 1944(V)                             |
| Minimum Illumination  |  | 0.2 lux (Color)<br>0.02 lux (B/W)  |   |
| White Balance         |  | Manual / AWB/ ATW  |   |
| Shutter Speed         |  | 1~ 1/10000 sec.  |   |
| Lens                  |  |  |   |
| Lens                  |  | C / CS Mount   |   |
| Operation             |  |  |   |
| Multiple Languages    |  | English / French / German / Italian / Korean / Simplified Chinese / Traditional Chinese / Russian        |   |
| Image Setting         | Backlight Compensation   | On / Off   |   |
|                       | White Balance  | Auto / Manual  |   |
|                       | Noise Reduction (3D)   | On / Off   |   |
|                       | Wide Dynamic Range   | On / Off   |   |
|                       | Privacy Mask   | On / Off   |   |
|                       | Brightness   | Manual   |   |
|                       | Exposure   | Auto / Manual  |   |
|                       | Sharpness  | Manual   |   |
|                       | Contrast   | Manual   |   |
|                       | Saturation   | Manual   |   |
|                       | Hue  | Manual   |   |
|                       | Digital Zoom   | Support  |   |
|                       | Motion Detection   | On / Off   |   |
|                       | Privacy Mask Type  | Color  |   |
| Audio                 | ICR*   | Auto / On / Off / Smart  |   |
|                       | Tampering Alarm  | On / Off   |   |
|                       | Two-way Audio  | Line out, Line in / Mic in   |   |
| Compression           | G.711 / G.726  |  |   |
| Network               |  |  |   |
| Interface             |  | RJ-45, 10/100 Mbps Ethernet  |   |
| Video Compression     |  | H.264 / MJPEG  |   |
| Video Streaming       | Single Stream- 2048 x 1536   |  | Single Stream-<br>2592 x 1944 / 2048 x 1536   |
|                       | Dual Streams- H.264 + H.264 / MJPEG  |  |   |
|                       | Quad Streams- H.264 + H.264 + H.264 + H.264 / MJPEG  |  |   |
| Video Resolution      | H.264- 2048 x 1536 (3M)  |  | H.264- 2592 x 1944 (5M) /<br>2048 x 1536 (3M) |
|                       | H.264- Full HD 1080P / SXGA / HD 720P / XGA / SVGA / D1 / VGA / CIF<br>MJPEG- Full HD 1080P / SXGA / HD 720P / XGA / SVGA / D1 / VGA / CIF |  |   |
| Protocol              |  | IPv4/v6, TCP/IP, UDP, RTP, RTSP, HTTP, HTTPS, ICMP, FTP, SMTP, DHCP, PPPoE, UPnP, IGMP, SNMP, QoS, ONVIF |   |
| Security              |  | HTTPS / IP Filter / IEEE 802.1x  |   |
| Alarm                 | Input  | 1 Set<br>5V 10kΩ pull up   |   |
|                       | Output   | 1 Set<br>Photo Relay Output 300V DC/AC   |   |
| Event Notification    |  | HTTP / FTP / SMTP  |   |
| Micro SD              |  | microSDHC 32GB support   |   |
| Supported Web Browser |  | Internet Explorer (6.0+) / Chrome / Firefox / Safari   |   |
| User Account          |  | 20   |   |
| Password Levels       |  | User and Administrator   |   |
| Mechanical            |  |  |   |
| Lens Mounting         |  | C / CS Mount   |   |
| LED Indicator         |  | Power / Link / ACT   |   |
| Connectors            | Auto Iris  | DC Drive   |   |
|                       | Alarm  | 4 Pin Terminal Block, Pitch 3.5 mm   |   |
|                       | Power  | DC 12V / 3 Pin Terminal Block  |   |
|                       | Ethernet   | RJ-45  |   |
|                       | Analog Video   | 1.0 Vp-p / 75 Ω, BNC   |   |
|                       | RS-485*  | D+, D-   |   |
|                       | Audio  | Stereo Phone Jack, Ø 3.5 mm  |   |



| <b>General</b>        |                                       |     |
|-----------------------|---------------------------------------|-----|
| Operating Temperature | -10°C ~ 50°C (14°F ~ 122°F)           |     |
| Humidity              | 10% ~ 90%, No Condensation            |     |
| Dimension             | 125 x 82 x 52 mm (L x W x H) w/o Lens |     |
| Weight                | 330 g (0.73 lb)                       |     |
| Power Source          | DC 12V / PoE<br>DC 12V / AC 24V / PoE |     |
| Power Consumption     | 3.7 W                                 | 4 W |
| Regulatory            | CE / FCC / RoHS                       |     |

(\*) Optional

## Appendix B: Delete the Existing DC Viewer

For users who have installed the DC Viewer in the PC previously, please first delete the existing DC Viewer from the PC before accessing to this IP Camera.

### **Deleting the DC Viewer**

In the Windows <Start Menu>, activate <Control Panel>, and then double click on <Add or Remove Programs>. In the <Currently installed programs> list, select <DCViewer> and click on the button <Remove> to uninstall the existing DC Viewer.

### **Deleting Temporary Internet Files**

To improve browser performance, it is suggested to clean up the all the files in the Temporary Internet Files.

The procedure is as follows:

**Step 1:** Click on the <Tools> tab on the menu bar and select <Internet Options>.

**Step 2:** Click on the <Delete> button under <Browsing history> section. Then click on the <Delete Files> button under the <Temporary Internet files> section.

**Step 3:** A confirmation window will pop up. Click on <Yes> to start deleting the files.

## Appendix C: Setup Internet Security

If ActiveX control installation is blocked, please either set Internet security level to default or change ActiveX controls and plug-ins settings.

### **Internet Security Level: Default**

**Step 1:** Start the Internet Explorer (IE).

**Step 2:** Click on the <Tools> tab on the menu bar and select <Internet Options>.

**Step 3:** Click on the <Security> tab, and select <Internet> zone.

**Step 4:** Down the page, click on the <Default Level> button and click on <OK> to confirm the setting. Close the browser window, and restart a new one later to access the IP Camera.

### **ActiveX Controls and Plug-ins Settings**

**Step 1:** Repeat **Steps 1~3** of the previous section above.

**Step 2:** Down the page, click on the <Custom Level> button to change ActiveX controls and plug-ins settings. The Security Settings window will pop up.

**Step 3:** Under <ActiveX controls and plug-ins>, set **ALL** items (as listed below) to <Enable> or <Prompt>. Please note that the items vary by IE version.

#### **ActiveX controls and plug-ins settings:**

1. Allow previously unused ActiveX controls to run without prompt.
2. Allow Scriptlets.
3. Automatic prompting for ActiveX controls.
4. Binary and script behaviors.
5. Display video and animation on a webpage that does not use external media player.
6. Download signed ActiveX controls.
7. Download unsigned ActiveX controls.
8. Initialize and script ActiveX controls not marked as safe for scripting.
9. Run ActiveX controls and plug-ins.
10. Script ActiveX controls marked safe for scripting.

**Step 4:** Click on <OK> to accept the settings and close the Security Settings window.

**Step 5:** Click on <OK> to close the Internet Options screen.

**Step 6:** Close the browser window, and restart a new one later to access the IP Camera.

# Appendix D: Back Focus Adjustment

## When to adjust back focus

Back Focus refers to the distance from the rear lens element to the camera focal plane. In most cases, it is required to adjust back focus only when the camera's lens cannot hold focus throughout its zoom range.

## What requirements

Tools required when carrying out back focus adjustment include:

1. Back focus adjuster (in the IP Camera's package)
2. Test chart / contrasting object

## How to adjust back focus

**Step 1:** Set the camera on a stable mount, with the test chart or object at least 75 feet (23 meters) away (or as far as possible).

**Step 2:** Make sure the iris is wide open. Therefore, it is advised to keep the environment in low light condition.

**Step 3:** Adjust the focus to infinite far ( $\infty$ ).

**Step 4:** Turn the zoom to the extreme telephoto position, and then focus on the subject.

**Step 5:** Set the zoom to wide-angle position.

**Step 6:** Loosen the back focus ring's retaining screw with the supplied adjuster, and adjust the back focus ring for sharp picture.

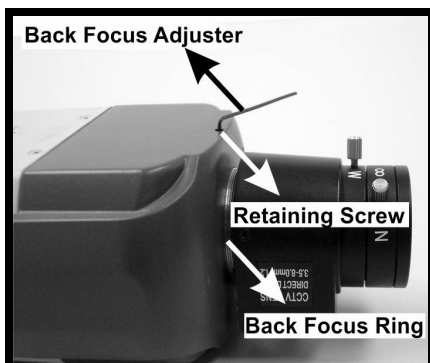

**Step 7:** Repeat steps 3 ~ 6 until focus can stay the same throughout the zoom range.

**Step 8:** Tighten the back focus ring's retaining screw to fix the ring.

# Appendix D: Video Resolution

## 2M- Quad Streams

| H.264 + H.264 + H.264 + H.264 / MJPEG |                      |                    |                    |                    |                    |
|---------------------------------------|----------------------|--------------------|--------------------|--------------------|--------------------|
| H.264-1                               | H.264-2              | H.264-3            | H.264-4 / MJPEG    |                    |                    |
| 1920 x 1080 (15 fps)                  | 1280 x 1024 (15 fps) | 720 x 480 (15 fps) | 352 x 240 (30 fps) |                    |                    |
|                                       |                      | 640 x 480 (15 fps) | 352 x 240 (30 fps) |                    |                    |
|                                       |                      | 352 x 240 (30 fps) | 352 x 240 (30 fps) |                    |                    |
|                                       | 1280 x 720 (15 fps)  | 800 x 600 (15 fps) |                    | 720 x 480 (15 fps) |                    |
|                                       |                      |                    |                    | 640 x 480 (15 fps) |                    |
|                                       |                      |                    |                    | 352 x 240 (30 fps) |                    |
|                                       |                      | 720 x 480 (15 fps) |                    | 720 x 480 (15 fps) | 720 x 480 (15 fps) |
|                                       |                      |                    |                    | 640 x 480 (15 fps) | 640 x 480 (15 fps) |
|                                       |                      |                    |                    | 720 x 480 (30 fps) | 352 x 240 (30 fps) |
|                                       |                      |                    |                    | 640 x 480 (15 fps) | 640 x 480 (30 fps) |
|                                       |                      |                    |                    | 640 x 480 (30 fps) | 352 x 240 (30 fps) |
|                                       | 1024 x 768 (15 fps)  | 800 x 600 (15 fps) |                    | 720 x 480 (15 fps) |                    |
|                                       |                      |                    |                    | 640 x 480 (15 fps) |                    |
|                                       |                      |                    |                    | 352 x 240 (30fps)  |                    |
|                                       |                      | 720 x 480 (15 fps) |                    | 720 x 480 (30 fps) | 640 x 480 (30 fps) |
|                                       |                      |                    |                    | 720 x 480 (30 fps) | 352 x 240 (30 fps) |
|                                       |                      |                    |                    | 640 x 480 (15 fps) | 640 x 480 (30 fps) |
|                                       | 800 x 600 (15 fps)   | 800 x 600 (15 fps) |                    | 720 x 480 (30 fps) |                    |
|                                       |                      |                    |                    | 640 x 480 (15 fps) |                    |
|                                       |                      |                    |                    | 640 x 480 (30 fps) |                    |
|                                       |                      |                    |                    | 352 x 240 (30 fps) |                    |
|                                       |                      |                    |                    | 352 x 240 (30 fps) |                    |
|                                       | 800 x 600 (30 fps)   | 800 x 600 (30 fps) |                    | 720 x 480 (30 fps) |                    |
|                                       |                      |                    |                    | 640 x 480 (30 fps) |                    |
|                                       |                      |                    |                    | 352 x 240 (30 fps) |                    |
|                                       | 720 x 480 (15 fps)   | 720 x 480 (15 fps) |                    | 720 x 480 (30 fps) |                    |
|                                       |                      |                    |                    | 640 x 480 (30 fps) |                    |
|                                       | 720 x 480 (30 fps)   | 720 x 480 (30 fps) |                    | 640 x 480 (30 fps) |                    |
|                                       |                      |                    |                    | 352 x 240 (30 fps) |                    |
|                                       |                      |                    |                    | 352 x 240 (30 fps) |                    |
|                                       | 640 x 480 (30 fps)   | 640 x 480 (30 fps) |                    | 640 x 480 (30 fps) |                    |
|                                       |                      |                    |                    | 352 x 240 (30 fps) |                    |
|                                       | 352 x 240 (30 fps)   | 352 x 240 (30 fps) |                    | 352 x 240 (30 fps) |                    |
|                                       |                      |                    | 352 x 240 (30 fps) |                    |                    |

| H.264 + H.264 + H.264 + H.264 / MJPEG |                      |                     |                     |                    |
|---------------------------------------|----------------------|---------------------|---------------------|--------------------|
| H.264-1                               | H.264-2              | H.264-3             | H.264-4 / MJPEG     |                    |
| 1280 x 1024 (15 fps)                  | 1280 x 1024 (15 fps) | 1280 x 720 (15 fps) | 720 x 480 (30 fps)  |                    |
|                                       |                      |                     | 640 x 480 (30 fps)  |                    |
|                                       |                      |                     | 352 x 240 (30 fps)  |                    |
|                                       |                      | 800 x 600 (15 fps)  | 720 x 480 (30 fps)  |                    |
|                                       |                      |                     | 640 x 480 (30 fps)  |                    |
|                                       |                      |                     | 352 x 240 (30 fps)  |                    |
|                                       |                      | 800 x 600 (30 fps)  | 720 x 480 (30 fps)  |                    |
|                                       | 352 x 240 (30 fps)   |                     |                     |                    |
|                                       | 720 x 480 (15 fps)   | 720 x 480 (30 fps)  |                     |                    |
|                                       |                      | 352 x 240 (30 fps)  |                     |                    |
|                                       | 720 x 480 (30 fps)   | 640 x 480 (30 fps)  |                     |                    |
|                                       |                      | 352 x 240 (30 fps)  |                     |                    |
|                                       | 640 x 480 (30 fps)   | 640 x 480 (30 fps)  |                     |                    |
|                                       |                      | 352 x 240 (30 fps)  |                     |                    |
|                                       | 352 x 240 (30 fps)   | 352 x 240 (30 fps)  |                     |                    |
|                                       | 1280 x 720 (15 fps)  | 1280 x 720 (15 fps) | 1280 x 720 (15 fps) | 720 x 480 (30 fps) |
|                                       |                      |                     |                     | 640 x 480 (30 fps) |
|                                       |                      |                     |                     | 352 x 240 (30 fps) |
|                                       |                      |                     | 800 x 600 (30 fps)  | 720 x 480 (30 fps) |
|                                       |                      | 640 x 480 (30 fps)  |                     |                    |
|                                       |                      | 352 x 240 (30 fps)  |                     |                    |
|                                       |                      | 720 x 480 (30 fps)  | 720 x 480 (30 fps)  |                    |
|                                       |                      |                     | 640 x 480 (30 fps)  |                    |
|                                       |                      |                     | 352 x 240 (30 fps)  |                    |
|                                       |                      | 640 x 480 (30 fps)  | 640 x 480 (30 fps)  |                    |
|                                       |                      |                     | 352 x 240 (30 fps)  |                    |
|                                       |                      | 1280 x 720 (30 fps) | 352 x 240 (30 fps)  | 352 x 240 (30 fps) |
|                                       | 1024 x 768 (15 fps)  | 800 x 600 (30 fps)  | 720 x 480 (30 fps)  |                    |
|                                       |                      |                     | 640 x 480 (30 fps)  |                    |
|                                       |                      |                     | 352 x 240 (30 fps)  |                    |
|                                       |                      |                     | 720 x 480 (30 fps)  |                    |
|                                       | 720 x 480 (30 fps)   | 640 x 480 (30 fps)  |                     |                    |
| 352 x 240 (30 fps)                    |                      |                     |                     |                    |
| 640 x 480 (30 fps)                    |                      |                     |                     |                    |
| 1024 x 768 (30 fps)                   | 720 x 480 (30 fps)   |                     |                     |                    |
|                                       | 640 x 480 (30 fps)   |                     |                     |                    |
|                                       | 352 x 240 (30 fps)   |                     |                     |                    |
| 800 x 600 (15 fps)                    | 800 x 600 (30 fps)   | 720 x 480 (30 fps)  |                     |                    |
| 800 x 600 (30 fps)                    | 800 x 600 (30 fps)   | 640 x 480 (30 fps)  |                     |                    |
|                                       |                      | 352 x 240 (30 fps)  |                     |                    |
|                                       | 720 x 480 (30 fps)   | 720 x 480 (30 fps)  |                     |                    |
|                                       |                      | 640 x 480 (30 fps)  |                     |                    |
|                                       | 640 x 480 (30 fps)   | 352 x 240 (30 fps)  |                     |                    |
|                                       |                      | 640 x 480 (30 fps)  |                     |                    |
| 720 x 480 (30 fps)                    | 720 x 480 (30 fps)   | 720 x 480 (30 fps)  |                     |                    |
|                                       |                      | 640 x 480 (30 fps)  |                     |                    |
|                                       | 640 x 480 (30 fps)   | 352 x 240 (30 fps)  |                     |                    |
|                                       |                      | 640 x 480 (30 fps)  |                     |                    |
| 640 x 480 (30 fps)                    | 640 x 480 (30 fps)   |                     |                     |                    |
|                                       | 352 x 240 (30 fps)   |                     |                     |                    |
| 1280 x 1024 (30 fps)                  | 800 x 600 (30 fps)   | 352 x 240 (30 fps)  | 352 x 240 (30 fps)  |                    |
|                                       | 720 x 480 (30 fps)   | 352 x 240 (30 fps)  | 352 x 240 (30 fps)  |                    |
|                                       | 640 x 480 (30 fps)   | 352 x 240 (30 fps)  | 352 x 240 (30 fps)  |                    |
|                                       | 352 x 240 (30 fps)   | 352 x 240 (30 fps)  | 352 x 240 (30 fps)  |                    |

| H.264 + H.264 + H.264 + H.264 / MJPEG |                     |                     |  |  |  |
|---------------------------------------|---------------------|---------------------|--|--|--|
| H.264-1                               | H.264-2             | H.264-3             | H.264-4 / MJPEG  |  |  |
| 1280 x 720 (15 fps)                   | 1280 x 720 (15 fps) | 1280 x 720 (15 fps) | 720 x 480 (30 fps)<br>640 x 480 (30 fps)                       |  |  |
|                                       |                     | 1280 x 720 (30 fps) | 352 x 240 (30 fps)   |  |  |
|                                       |                     | 800 x 600 (30 fps)  | 720 x 480 (30 fps)<br>640 x 480 (30 fps)                       |  |  |
|                                       |                     | 720 x 480 (30 fps)  | 720 x 480 (30 fps)<br>640 x 480 (30 fps)                       |  |  |
|                                       |                     | 640 x 480 (30 fps)  | 640 x 480 (30 fps)   |  |  |
|                                       | 1280 x 720 (30 fps) | 1280 x 720 (30 fps) | 800 x 600 (30 fps)   | 352 x 240 (30 fps)   |  |
|                                       |                     |                     | 720 x 480 (30 fps)   | 352 x 240 (30 fps)   |  |
|                                       |                     |                     | 640 x 480 (30 fps)   | 352 x 240 (30 fps)   |  |
|                                       |                     |                     | 352 x 240 (30 fps)   | 352 x 240 (30 fps)   |  |
|                                       | 1024 x 768 (15 fps) | 1024 x 768 (15 fps) | 800 x 600 (30 fps)   | 720 x 480 (30 fps)<br>640 x 480 (30 fps)                       |  |
|                                       |                     |                     |  |  |  |
|                                       | 1024 x 768 (30 fps) | 1024 x 768 (30 fps) | 800 x 600 (30 fps)   | 352 x 240 (30 fps)   |  |
|                                       |                     |                     | 720 x 480 (30 fps)   | 720 x 480 (30 fps)<br>640 x 480 (30 fps)<br>352 x 240 (30 fps) |  |
|                                       |                     |                     | 640 x 480 (30 fps)   | 640 x 480 (30 fps)<br>352 x 240 (30 fps)                       |  |
|                                       |                     | 800 x 600 (30 fps)  | 800 x 600 (30 fps)   | 800 x 600 (30 fps)   | 720 x 480 (30 fps)<br>640 x 480 (30 fps)<br>352 x 240 (30 fps) |
|                                       |                     |                     |  | 720 x 480 (30 fps)   | 720 x 480 (30 fps)<br>640 x 480 (30 fps)                       |
|                                       |                     |                     |  | 640 x 480 (30 fps)   | 640 x 480 (30 fps)   |
|                                       | 1280 x 720 (30 fps) | 1024 x 768 (30 fps) | 352 x 240 (30 fps)   | 352 x 240 (30 fps)   |  |
|                                       |                     | 800 x 600 (30 fps)  | 800 x 600 (30 fps)   | 720 x 480 (30 fps)<br>352 x 240 (30 fps)                       |  |
|                                       |                     |                     | 720 x 480 (30 fps)   | 640 x 480 (30 fps)<br>352 x 240 (30 fps)                       |  |
| 640 x 480 (30 fps)                    |                     |                     | 640 x 480 (30 fps)<br>352 x 240 (30 fps)                       |  |  |
| 720 x 480 (30 fps)                    |                     | 720 x 480 (30 fps)  | 720 x 480 (30 fps)   | 640 x 480 (30 fps)<br>352 x 240 (30 fps)                       |  |
|                                       |                     |                     | 640 x 480 (30 fps)   | 640 x 480 (30 fps)<br>352 x 240 (30 fps)                       |  |
|                                       |                     |                     | 352 x 240 (30 fps)   | 352 x 240 (30 fps)   |  |
| 640 x 480 (30 fps)                    |                     | 640 x 480 (30 fps)  | 640 x 480 (30 fps)   | 640 x 480 (30 fps)<br>352 x 240 (30 fps)                       |  |
|                                       |                     |                     | 352 x 240 (30 fps)   | 352 x 240 (30 fps)   |  |
| 352 x 240 (30 fps)                    |                     | 352 x 240 (30 fps)  | 352 x 240 (30 fps)   | 352 x 240 (30 fps)   |  |
| 1024 x 768 (15 fps)                   | 1024 x 768 (15 fps) | 800 x 600 (30 fps)  | 720 x 480 (30 fps)<br>640 x 480 (30 fps)                       |  |  |
|                                       | 1024 x 768 (30 fps) | 800 x 600 (30 fps)  | 352 x 240 (30 fps)   |  |  |
|                                       |                     | 720 x 480 (30 fps)  | 720 x 480 (30 fps)<br>640 x 480 (30 fps)<br>352 x 240 (30 fps) |  |  |
|                                       |                     | 640 x 480 (30 fps)  | 640 x 480 (30 fps)   |  |  |
|                                       | 800 x 600 (30 fps)  | 800 x 600 (30 fps)  | 800 x 600 (30 fps)   | 720 x 480 (30 fps)<br>640 x 480 (30 fps)                       |  |
|                                       |                     |                     |  |  |  |





## 2M- Triple Streams

| H.264-1 + H.264-2 + H.264-3 / MJPEG |                      |                     |                     |
|-------------------------------------|----------------------|---------------------|---------------------|
| H.264-1                             | H.264-2              | H.264-3 / MJPEG     |                     |
| 1920 x 1080 (15 fps)                | 1280 x 1024 (15 fps) | 800 x 600 (15 fps)  |                     |
|                                     |                      | 720 x 480 (15 fps)  |                     |
|                                     |                      | 640 x 480 (15 fps)  |                     |
|                                     |                      | 352 x 240 (30 fps)  |                     |
|                                     | 1280 x 720 (15 fps)  | 1280 x 720 (15 fps) | 1280 x 720 (15 fps) |
|                                     |                      |                     | 800 x 600 (15 fps)  |
|                                     |                      |                     | 720 x 480 (30 fps)  |
|                                     |                      |                     | 640 x 480 (30 fps)  |
|                                     |                      |                     | 352 x 240 (30 fps)  |
|                                     | 1024 x 768 (15 fps)  | 1024 x 768 (15 fps) | 800 x 600 (30 fps)  |
|                                     |                      |                     | 720 x 480 (30 fps)  |
|                                     | 1024 x 768 (30 fps)  | 352 x 240 (30 fps)  | 640 x 480 (30 fps)  |
|                                     | 800 x 600 (15 fps)   | 800 x 600 (30 fps)  | 800 x 600 (30 fps)  |
|                                     | 800 x 600 (30 fps)   | 800 x 600 (30 fps)  | 720 x 480 (30 fps)  |
| 640 x 480 (30 fps)                  |                      |                     |                     |
| 352 x 240 (30 fps)                  |                      |                     |                     |
| 720 x 480 (30 fps)                  | 720 x 480 (30 fps)   | 720 x 480 (30 fps)  |                     |
|                                     |                      | 640 x 480 (30 fps)  |                     |
|                                     |                      | 352 x 240 (30 fps)  |                     |
| 640 x 480 (30 fps)                  | 640 x 480 (30 fps)   | 640 x 480 (30 fps)  |                     |
|                                     |                      | 352 x 240 (30 fps)  |                     |
| 352 x 240 (30fps)                   | 352 x 240 (30fps)    | 352 x 240 (30fps)   |                     |
| 1280 x 1024 (15 fps)                | 1280 x 1024 (15 fps) | 1280 x 720 (15 fps) |                     |
|                                     |                      | 800 x 600 (30 fps)  |                     |
|                                     |                      | 720 x 480 (30 fps)  |                     |
|                                     |                      | 640 x 480 (30 fps)  |                     |
|                                     |                      | 352 x 240 (30 fps)  |                     |
|                                     | 1280 x 720 (15 fps)  | 1280 x 720 (15 fps) | 1280 x 720 (15 fps) |
|                                     |                      |                     | 800 x 600 (30 fps)  |
|                                     | 1280 x 720 (30 fps)  | 1280 x 720 (30 fps) | 720 x 480 (30 fps)  |
|                                     |                      |                     | 640 x 480 (30 fps)  |
|                                     |                      |                     | 352 x 240 (30 fps)  |
|                                     | 1024 x 768 (30 fps)  | 1024 x 768 (30 fps) | 800 x 600 (30 fps)  |
|                                     |                      |                     | 720 x 480 (30 fps)  |
|                                     |                      |                     | 640 x 480 (30 fps)  |
|                                     |                      |                     | 352 x 240 (30 fps)  |
| 800 x 600 (30 fps)                  | 800 x 600 (30 fps)   | 800 x 600 (30 fps)  |                     |
|                                     |                      | 720 x 480 (30 fps)  |                     |
|                                     |                      | 640 x 480 (30 fps)  |                     |
| 720 x 480 (30 fps)                  | 720 x 480 (30 fps)   | 720 x 480 (30 fps)  |                     |
| 800 x 600 (30 fps)                  | 352 x 240 (30 fps)   | 640 x 480 (30 fps)  |                     |
| 1280 x 1024 (30 fps)                | 720 x 480 (30 fps)   | 640 x 480 (30 fps)  |                     |
|                                     |                      | 352 x 240 (30 fps)  |                     |
|                                     |                      | 640 x 480 (30 fps)  |                     |
|                                     |                      | 352 x 240 (30 fps)  |                     |
|                                     |                      | 352 x 240 (30 fps)  |                     |
| 1280 x 720 (15 fps)                 | 1280 x 720 (15 fps)  | 1280 x 720 (30 fps) |                     |
|                                     |                      | 800 x 600 (30 fps)  |                     |
|                                     | 1280 x 720 (30 fps)  | 1280 x 720 (30 fps) | 720 x 480 (30 fps)  |
|                                     |                      |                     | 640 x 480 (30 fps)  |
|                                     |                      |                     | 800 x 600 (30 fps)  |
|                                     | 1024 x 768 (30 fps)  | 1024 x 768 (30 fps) | 720 x 480 (30 fps)  |
| 640 x 480 (30 fps)                  |                      |                     |                     |

| H.264-1 + H.264-2 + H.264-3 / MJPEG |                     |                    |                    |
|-------------------------------------|---------------------|--------------------|--------------------|
| H.264-1                             | H.264-2             | H.264-3 / MJPEG    |                    |
| 1280 x 720 (30 fps)                 | 1280 x 720 (30 fps) | 352 x 240 (30 fps) |                    |
|                                     | 1024 x 768 (30 fps) | 352 x 240 (30 fps) |                    |
|                                     | 800 x 600 (30 fps)  |                    | 800 x 600 (30 fps) |
|                                     |                     |                    | 720 x 480 (30 fps) |
|                                     |                     |                    | 640 x 480 (30 fps) |
|                                     |                     |                    | 352 x 240 (30 fps) |
|                                     | 720 x 480 (30 fps)  |                    | 720 x 480 (30 fps) |
|                                     |                     |                    | 640 x 480 (30 fps) |
| 352 x 240 (30 fps)                  |                     |                    |                    |
| 640 x 480 (30 fps)                  |                     | 640 x 480 (30 fps) |                    |
| 352 x 240 (30 fps)                  |                     | 352 x 240 (30 fps) |                    |
| 1024 x 768 (15 fps)                 | 1024 x 768 (30 fps) | 800 x 600 (30 fps) |                    |
| 1024 x 768 (30 fps)                 | 1024 x 768 (30 fps) | 720 x 480 (30 fps) |                    |
|                                     |                     | 640 x 480 (30 fps) |                    |
|                                     |                     | 352 x 240 (30 fps) |                    |
|                                     | 800 x 600 (30 fps)  |                    | 800 x 600 (30 fps) |
|                                     |                     |                    | 720 x 480 (30 fps) |
|                                     |                     |                    | 640 x 480 (30 fps) |
|                                     |                     |                    | 352 x 240 (30 fps) |
|                                     | 720 x 480 (30 fps)  |                    | 720 x 480 (30 fps) |
|                                     |                     |                    | 640 x 480 (30 fps) |
|                                     |                     |                    | 352 x 240 (30 fps) |
|                                     | 640 x 480 (30 fps)  |                    | 640 x 480 (30 fps) |
|                                     |                     |                    | 352 x 240 (30 fps) |
| 352 x 240 (30 fps)                  |                     | 352 x 240 (30 fps) |                    |
| 800 x 600 (30 fps)                  | 800 x 600 (30 fps)  | 800 x 600 (30 fps) |                    |
|                                     |                     | 720 x 480 (30 fps) |                    |
|                                     |                     | 640 x 480 (30 fps) |                    |
|                                     |                     | 352 x 240 (30 fps) |                    |
|                                     | 720 x 480 (30 fps)  |                    | 720 x 480 (30 fps) |
|                                     |                     |                    | 640 x 480 (30 fps) |
|                                     |                     |                    | 352 x 240 (30 fps) |
|                                     |                     |                    | 352 x 240 (30 fps) |
| 640 x 480 (30 fps)                  |                     | 640 x 480 (30 fps) |                    |
|                                     |                     | 352 x 240 (30 fps) |                    |
|                                     |                     | 352 x 240 (30 fps) |                    |
|                                     |                     | 352 x 240 (30 fps) |                    |
| 720 x 480 (30 fps)                  | 720 x 480 (30 fps)  | 720 x 480 (30 fps) |                    |
|                                     |                     | 640 x 480 (30 fps) |                    |
|                                     |                     | 352 x 240 (30 fps) |                    |
|                                     | 640 x 480 (30 fps)  |                    | 640 x 480 (30 fps) |
|                                     |                     |                    | 352 x 240 (30 fps) |
| 352 x 240 (30 fps)                  |                     | 352 x 240 (30 fps) |                    |
| 640 x 480 (30 fps)                  | 640 x 480 (30 fps)  | 640 x 480 (30 fps) |                    |
|                                     |                     | 352 x 240 (30 fps) |                    |
|                                     | 352 x 240 (30 fps)  |                    | 352 x 240 (30 fps) |
| 352 x 240 (30 fps)                  | 352 x 240 (30 fps)  | 352 x 240 (30 fps) |                    |

## 2M- Dual Streams

| H.264-1 + H.264-2 / MJPEG |                      |             |
|---------------------------|----------------------|-------------|
| H.264-1                   | H.264-2 / MJPEG      | BNC SUPPORT |
| 1920 x 1080 (15 fps)      | 1280 x 1024 (15 fps) | -           |
|                           | 1280 x 720 (30 fps)  | -           |
|                           | 1024 x 768 (30 fps)  | -           |
|                           | 800 x 600 (30 fps)   | -           |
|                           | 720 x 480 (30 fps)   | √           |
|                           | 640 x 480 (30 fps)   | √           |
|                           | 352 x 240 (30 fps)   | √           |
| 1280 x 1024 (30 fps)      | 1280 x 1024 (15 fps) | √           |
|                           | 1280 x 720 (15 fps)  | -           |
|                           | 1024 x 768 (15 fps)  | -           |
|                           | 800 x 600 (30 fps)   | -           |
|                           | 720 x 480 (30 fps)   | √           |
|                           | 640 x 480 (30 fps)   | √           |
| 1280 x 720 (30 fps)       | 352 x 240 (30 fps)   | √           |
|                           | 1280 x 720 (30 fps)  | √           |
|                           | 1024 x 768 (30 fps)  | -           |
|                           | 800 x 600 (30 fps)   | -           |
|                           | 720 x 480 (30 fps)   | √           |
|                           | 640 x 480 (30 fps)   | √           |
| 1024 x 768 (30 fps)       | 352 x 240 (30 fps)   | √           |
|                           | 1024 x 768 (30 fps)  | √           |
|                           | 800 x 600 (30 fps)   | -           |
|                           | 720 x 480 (30 fps)   | √           |
|                           | 640 x 480 (30 fps)   | √           |
| 800 x 600 (30 fps)        | 352 x 240 (30 fps)   | √           |
|                           | 800 x 600 (30 fps)   | √           |
|                           | 720 x 480 (30 fps)   | √           |
|                           | 640 x 480 (30 fps)   | √           |
| 720 x 480 (30 fps)        | 352 x 240 (30 fps)   | √           |
|                           | 720 x 480 (30 fps)   | √           |
|                           | 640 x 480 (30 fps)   | √           |
| 640 x 480 (30 fps)        | 352 x 240 (30 fps)   | √           |
|                           | 640 x 480 (30 fps)   | √           |
| 352 x 240 (30 fps)        | 352 x 240 (30 fps)   | -           |

## 2M- Single Stream

| H.264 Only                       | BNC SUPPORT |
|----------------------------------|-------------|
| 1920 x 1080 (15 fps) Low Latency | -           |
| 1920 x 1080 (15 fps)             | √           |
| 1280 x 1024 (30 fps)             | √           |
| 1280 x 720 (30 fps)              | √           |
| 1024 x 768 (30 fps)              | √           |
| 800 x 600 (30 fps)               | √           |
| 720 x 480 (30 fps)               | √           |
| 640 x 480 (30 fps)               | √           |
| 352 x 240 (30 fps)               | -           |

| MJPEG Only           | BNC SUPPORT |
|----------------------|-------------|
| 1920 x 1080 (15 fps) | √           |
| 1280 x 1024 (30 fps) | √           |
| 1280 x 720 (30 fps)  | √           |
| 1024 x 768 (30 fps)  | √           |
| 800 x 600 (30 fps)   | √           |
| 720 x 480 (30 fps)   | √           |
| 640 x 480 (30 fps)   | √           |
| 352 x 240 (30 fps)   | -           |

## 2M Real time / 3M / 5M- Quad Streams

| H.264 + H.264 + H.264 + H.264 / MJPEG |                    |                    |                    |                    |
|---------------------------------------|--------------------|--------------------|--------------------|--------------------|
| H.264-1                               | H.264-2            | H.264-3            | H.264-4 / MJPEG    |                    |
| 2592 x 1944 (10 fps)                  | 720 x 480 (10 fps) | 720 x 480 (10 fps) | 352 x 240 (10 fps) |                    |
|                                       |                    | 640 x 480 (10 fps) | 640 x 480 (10 fps) |                    |
|                                       |                    | 352 x 240 (10 fps) | 352 x 240 (10 fps) |                    |
|                                       | 640 x 480 (10 fps) | 640 x 480 (10 fps) | 640 x 480 (10 fps) | 640 x 480 (10 fps) |
|                                       |                    | 640 x 480 (10 fps) | 352 x 240 (10 fps) | 352 x 240 (10 fps) |
|                                       |                    | 352 x 240 (10 fps) | 352 x 240 (10 fps) | 352 x 240 (10 fps) |

\*The resolution is for 5M Model only.

| H.264 + H.264 + H.264 + H.264 / MJPEG |                     |                    |                    |                    |                    |
|---------------------------------------|---------------------|--------------------|--------------------|--------------------|--------------------|
| H.264-1                               | H.264-2             | H.264-3            | H.264-4 / MJPEG    |                    |                    |
| 2048 x 1536 (15 fps)                  | 1280 x 720 (15 fps) | 720 x 480 (15 fps) | 640 x 480 (15 fps) |                    |                    |
|                                       |                     |                    | 352 x 240 (15 fps) |                    |                    |
|                                       |                     | 640 x 480 (15 fps) | 640 x 480 (15 fps) |                    |                    |
|                                       | 800 x 600 (15 fps)  | 800 x 600 (15 fps) | 352 x 240 (15 fps) | 352 x 240 (15 fps) |                    |
|                                       |                     |                    | 800 x 600 (15 fps) | 720 x 480 (15 fps) |                    |
|                                       |                     |                    | 800 x 600 (15 fps) | 640 x 480 (15 fps) |                    |
|                                       |                     | 720 x 480 (15 fps) | 720 x 480 (15 fps) | 352 x 240 (15 fps) | 352 x 240 (15 fps) |
|                                       |                     |                    | 640 x 480 (15 fps) | 640 x 480 (15 fps) | 640 x 480 (15 fps) |
|                                       |                     |                    | 352 x 240 (15 fps) | 352 x 240 (15 fps) | 352 x 240 (15 fps) |
|                                       | 720 x 480 (15 fps)  | 720 x 480 (15 fps) | 720 x 480 (15 fps) | 720 x 480 (15 fps) |                    |
|                                       |                     |                    |                    | 640 x 480 (15 fps) |                    |
|                                       |                     |                    |                    | 352 x 240 (15 fps) |                    |
|                                       |                     | 640 x 480 (15 fps) | 640 x 480 (15 fps) | 640 x 480 (15 fps) | 640 x 480 (15 fps) |
|                                       |                     |                    | 352 x 240 (15 fps) | 352 x 240 (15 fps) | 352 x 240 (15 fps) |
|                                       |                     |                    | 352 x 240 (15 fps) | 352 x 240 (15 fps) | 352 x 240 (15 fps) |

\*The resolution is for 3M & 5M Model only.

| H.264 + H.264 + H.264 + H.264 / MJPEG |                      |                     |                    |                    |
|---------------------------------------|----------------------|---------------------|--------------------|--------------------|
| H.264-1                               | H.264-2              | H.264-3             | H.264-4 / MJPEG    |                    |
| 1920 x 1080 (15 fps)                  | 1280 x 1024 (15 fps) | 1280 x 720 (15 fps) | 720 x 480 (15 fps) |                    |
|                                       |                      |                     | 640 x 480 (15 fps) |                    |
|                                       |                      |                     | 352 x 240 (30 fps) |                    |
|                                       |                      | 1280 x 720 (15 fps) | 800 x 600 (15 fps) | 720 x 480 (30 fps) |
|                                       |                      |                     |                    | 640 x 480 (30 fps) |
|                                       |                      |                     | 800 x 600 (30 fps) | 352 x 240 (30 fps) |
|                                       |                      |                     |                    | 720 x 480 (30 fps) |
|                                       | 720 x 480 (15 fps)   |                     | 720 x 480 (30 fps) |                    |
|                                       |                      |                     | 640 x 480 (30 fps) |                    |
|                                       | 720 x 480 (30 fps)   | 640 x 480 (30 fps)  |                    |                    |
|                                       |                      | 352 x 240 (30 fps)  |                    |                    |
|                                       | 1280 x 720 (30 fps)  | 1280 x 720 (15 fps) | 800 x 600 (30 fps) | 720 x 480 (30 fps) |
|                                       |                      |                     |                    | 640 x 480 (30 fps) |
|                                       |                      |                     | 720 x 480 (30 fps) | 720 x 480 (30 fps) |
|                                       |                      |                     |                    | 640 x 480 (30 fps) |
|                                       | 1024 x 768 (15 fps)  | 800 x 600 (30 fps)  | 720 x 480 (30 fps) |                    |
|                                       |                      |                     | 640 x 480 (30 fps) |                    |
|                                       |                      |                     | 352 x 240 (30 fps) |                    |
|                                       | 1024 x 768 (30 fps)  | 800 x 600 (30 fps)  | 720 x 480 (30 fps) |                    |
|                                       |                      |                     | 640 x 480 (30 fps) |                    |
|                                       |                      |                     | 640 x 480 (30 fps) |                    |
|                                       |                      |                     | 352 x 240 (30 fps) |                    |
|                                       | 800 x 600 (30 fps)   | 800 x 600 (30 fps)  | 720 x 480 (30 fps) | 720 x 480 (30 fps) |
|                                       |                      |                     |                    | 640 x 480 (30 fps) |
|                                       |                      |                     |                    | 352 x 240 (30 fps) |
|                                       |                      | 720 x 480 (30 fps)  | 720 x 480 (30 fps) | 640 x 480 (30 fps) |
|                                       |                      |                     |                    | 640 x 480 (30 fps) |
|                                       |                      |                     |                    | 352 x 240 (30 fps) |
|                                       |                      | 720 x 480 (30 fps)  | 640 x 480 (30 fps) | 640 x 480 (30 fps) |
|                                       |                      |                     |                    | 352 x 240 (30 fps) |
|                                       | 720 x 480 (30 fps)   | 720 x 480 (30 fps)  | 720 x 480 (30 fps) |                    |
|                                       |                      |                     | 640 x 480 (30 fps) |                    |
| 352 x 240 (30 fps)                    |                      |                     |                    |                    |
| 640 x 480 (30 fps)                    | 640 x 480 (30 fps)   | 640 x 480 (30 fps)  |                    |                    |
|                                       |                      | 640 x 480 (30 fps)  |                    |                    |
|                                       |                      | 352 x 240 (30 fps)  |                    |                    |
| 1920 x 1080 (30 fps)                  | 352 x 240 (30 fps)   | 352 x 240 (30 fps)  | 352 x 240 (30 fps) |                    |

| H.264 + H.264 + H.264 + H.264 / MJPEG |                      |                     |  |  |  |
|---------------------------------------|----------------------|---------------------|--|--|--|
| H.264-1                               | H.264-2              | H.264-3             | H.264-4 / MJPEG  |  |  |
| 1280 x 1024 (15 fps)                  | 1280 x 1024 (15 fps) | 1280 x 720 (15 fps) | 720 x 480 (30 fps)<br>640 x 480 (30 fps)                       |  |  |
|                                       |                      | 1280 x 720 (30 fps) | 352 x 240 (30 fps)   |  |  |
|                                       |                      | 800 x 600 (30 fps)  | 720 x 480 (30 fps)   | 720 x 480 (30 fps)   |  |
|                                       |                      |                     | 640 x 480 (30 fps)   | 640 x 480 (30 fps)   |  |
|                                       |                      |                     | 352 x 240 (30 fps)   | 352 x 240 (30 fps)   |  |
|                                       |                      | 720 x 480 (30 fps)  | 720 x 480 (30 fps)   | 720 x 480 (30 fps)   |  |
|                                       | 640 x 480 (30 fps)   |                     | 640 x 480 (30 fps)   |  |  |
|                                       | 640 x 480 (30 fps)   |                     | 640 x 480 (30 fps)   |  |  |
|                                       | 1280 x 1024 (30 fps) | 720 x 480 (30 fps)  | 352 x 240 (30 fps)   |  |  |
|                                       |                      | 640 x 480 (30 fps)  | 352 x 240 (30 fps)   |  |  |
|                                       |                      | 352 x 240 (30 fps)  | 352 x 240 (30 fps)   |  |  |
|                                       | 1280 x 720 (15 fps)  | 1280 x 720 (30 fps) | 720 x 480 (30 fps)   | 720 x 480 (30 fps)   |  |
|                                       |                      |                     | 640 x 480 (30 fps)   | 640 x 480 (30 fps)   |  |
|                                       |                      |                     | 352 x 240 (30 fps)   | 352 x 240 (30 fps)   |  |
|                                       | 1280 x 720 (30 fps)  | 800 x 600 (30 fps)  | 800 x 600 (30 fps)   | 720 x 480 (30 fps)<br>640 x 480 (30 fps)<br>352 x 240 (30 fps) |  |
|                                       |                      |                     | 720 x 480 (30 fps)   | 720 x 480 (30 fps)<br>640 x 480 (30 fps)<br>352 x 240 (30 fps) |  |
|                                       |                      |                     | 640 x 480 (30 fps)   | 640 x 480 (30 fps)<br>352 x 240 (30 fps)                       |  |
|                                       |                      | 640 x 480 (30 fps)  | 352 x 240 (30 fps)   | 640 x 480 (30 fps)   | 640 x 480 (30 fps)<br>352 x 240 (30 fps)                       |
|                                       |                      |                     |  | 352 x 240 (30 fps)   | 352 x 240 (30 fps)   |
|                                       |                      |                     |  | 352 x 240 (30 fps)   | 352 x 240 (30 fps)   |
|                                       |                      |                     |  | 352 x 240 (30 fps)   | 352 x 240 (30 fps)   |
|                                       |                      | 1024 x 768 (30 fps) | 800 x 600 (30 fps)   | 800 x 600 (30 fps)   | 720 x 480 (30 fps)<br>640 x 480 (30 fps)<br>352 x 240 (30 fps) |
|                                       |                      |                     |  | 720 x 480 (30 fps)   | 720 x 480 (30 fps)<br>640 x 480 (30 fps)<br>352 x 240 (30 fps) |
|                                       |                      |                     |  | 640 x 480 (30 fps)   | 640 x 480 (30 fps)<br>352 x 240 (30 fps)                       |
| 800 x 600 (30 fps)                    | 720 x 480 (30 fps)   |                     | 800 x 600 (30 fps)   | 720 x 480 (30 fps)<br>640 x 480 (30 fps)                       |  |
|                                       |                      |                     | 720 x 480 (30 fps)   | 720 x 480 (30 fps)<br>640 x 480 (30 fps)                       |  |
|                                       |                      |                     | 720 x 480 (30 fps)   | 720 x 480 (30 fps)   |  |
|                                       |                      |                     | 640 x 480 (30 fps)   | 640 x 480 (30 fps)   |  |
| 1280 x 1024 (30 fps)                  | 1024 x 768 (30 fps)  | 352 x 240 (30 fps)  | 352 x 240 (30 fps)   |  |  |
|                                       | 800 x 600 (30 fps)   | 800 x 600 (30 fps)  | 800 x 600 (30 fps)<br>720 x 480 (30 fps)<br>352 x 240 (30 fps) |  |  |
|                                       |                      | 640 x 480 (30 fps)  | 640 x 480 (30 fps)<br>352 x 240 (30 fps)                       |  |  |
|                                       |                      | 352 x 240 (30 fps)  | 352 x 240 (30 fps)   |  |  |
|                                       | 720 x 480 (30 fps)   | 720 x 480 (30 fps)  | 720 x 480 (30 fps)   | 720 x 480 (30 fps)<br>640 x 480 (30 fps)<br>352 x 240 (30 fps) |  |
|                                       |                      |                     | 640 x 480 (30 fps)   | 640 x 480 (30 fps)<br>352 x 240 (30 fps)                       |  |
|                                       |                      |                     | 352 x 240 (30 fps)   | 352 x 240 (30 fps)   |  |
|                                       |                      | 640 x 480 (30 fps)  | 352 x 240 (30 fps)   | 640 x 480 (30 fps)   | 640 x 480 (30 fps)<br>352 x 240 (30 fps)                       |
|                                       |                      |                     |  | 352 x 240 (30 fps)   | 352 x 240 (30 fps)   |
|                                       |                      |                     |  | 352 x 240 (30 fps)   | 352 x 240 (30 fps)   |
|                                       | 1280 x 720 (15 fps)  | 1280 x 720 (15 fps) | 1280 x 720 (30 fps)  | 720 x 480 (30 fps)<br>640 x 480 (30 fps)                       |  |
|                                       |                      | 1280 x 720 (30 fps) | 1280 x 720 (30 fps)  | 352 x 240 (30 fps)   |  |
| 800 x 600 (30 fps)                    |                      |                     | 720 x 480 (30 fps)<br>640 x 480 (30 fps)                       |  |  |
| 720 x 480 (30 fps)                    |                      |                     | 720 x 480 (30 fps)<br>640 x 480 (30 fps)                       |  |  |
| 640 x 480 (30 fps)                    |                      |                     | 640 x 480 (30 fps)   |  |  |
| 1024 x 768 (30 fps)                   |                      | 800 x 600 (30 fps)  | 720 x 480 (30 fps)<br>640 x 480 (30 fps)                       |  |  |

| H.264 + H.264 + H.264 + H.264 / MJPEG |                     |                     |                    |                    |                    |
|---------------------------------------|---------------------|---------------------|--------------------|--------------------|--------------------|
| H.264-1                               | H.264-2             | H.264-3             | H.264-4 / MJPEG    |                    |                    |
| 1280 x 720 (30 fps)                   | 1280 x 720 (30 fps) | 800 x 600 (30 fps)  | 352 x 240 (30 fps) |                    |                    |
|                                       |                     | 720 x 480 (30 fps)  | 352 x 240 (30 fps) |                    |                    |
|                                       |                     | 640 x 480 (30 fps)  | 352 x 240 (30 fps) |                    |                    |
|                                       |                     | 352 x 240 (30 fps)  | 352 x 240 (30 fps) |                    |                    |
|                                       | 1024 x 768 (30 fps) | 1024 x 768 (30 fps) | 800 x 600 (30 fps) | 352 x 240 (30 fps) |                    |
|                                       |                     |                     | 720 x 480 (30 fps) | 720 x 480 (30 fps) |                    |
|                                       |                     |                     | 640 x 480 (30 fps) | 640 x 480 (30 fps) |                    |
|                                       |                     |                     | 352 x 240 (30 fps) | 352 x 240 (30 fps) |                    |
|                                       | 800 x 600 (30 fps)  | 800 x 600 (30 fps)  | 800 x 600 (30 fps) | 720 x 480 (30 fps) |                    |
|                                       |                     |                     | 720 x 480 (30 fps) | 640 x 480 (30 fps) |                    |
|                                       |                     |                     | 640 x 480 (30 fps) | 352 x 240 (30 fps) |                    |
|                                       |                     |                     | 352 x 240 (30 fps) | 352 x 240 (30 fps) |                    |
|                                       |                     | 720 x 480 (30 fps)  | 720 x 480 (30 fps) | 720 x 480 (30 fps) | 720 x 480 (30 fps) |
|                                       |                     |                     |                    | 640 x 480 (30 fps) | 640 x 480 (30 fps) |
|                                       |                     |                     |                    | 640 x 480 (30 fps) | 352 x 240 (30 fps) |
|                                       |                     |                     |                    | 352 x 240 (30 fps) | 352 x 240 (30 fps) |
|                                       | 640 x 480 (30 fps)  | 640 x 480 (30 fps)  | 640 x 480 (30 fps) | 640 x 480 (30 fps) |                    |
|                                       |                     |                     | 352 x 240 (30 fps) | 352 x 240 (30 fps) |                    |
|                                       | 352 x 240 (30 fps)  | 352 x 240 (30 fps)  | 352 x 240 (30 fps) | 352 x 240 (30 fps) |                    |
|                                       | 1024 x 768 (30 fps) | 1024 x 768 (30 fps) | 800 x 600 (30 fps) | 720 x 480 (30 fps) |                    |
|                                       |                     |                     |                    | 640 x 480 (30 fps) |                    |
|                                       |                     |                     |                    | 352 x 240 (30 fps) |                    |
|                                       |                     |                     | 720 x 480 (30 fps) | 720 x 480 (30 fps) | 720 x 480 (30 fps) |
|                                       |                     | 640 x 480 (30 fps)  |                    |                    | 640 x 480 (30 fps) |
| 640 x 480 (30 fps)                    |                     | 352 x 240 (30 fps)  |                    |                    |                    |
| 352 x 240 (30 fps)                    |                     | 352 x 240 (30 fps)  |                    |                    |                    |
| 800 x 600 (30 fps)                    |                     | 800 x 600 (30 fps)  | 800 x 600 (30 fps) | 720 x 480 (30 fps) |                    |
|                                       |                     |                     | 720 x 480 (30 fps) | 640 x 480 (30 fps) |                    |
|                                       |                     |                     | 640 x 480 (30 fps) | 352 x 240 (30 fps) |                    |
|                                       |                     |                     | 352 x 240 (30 fps) | 352 x 240 (30 fps) |                    |
| 720 x 480 (30 fps)                    |                     | 720 x 480 (30 fps)  | 720 x 480 (30 fps) | 720 x 480 (30 fps) |                    |
|                                       |                     |                     | 640 x 480 (30 fps) | 640 x 480 (30 fps) |                    |
|                                       |                     |                     | 640 x 480 (30 fps) | 352 x 240 (30 fps) |                    |
|                                       |                     |                     | 352 x 240 (30 fps) | 352 x 240 (30 fps) |                    |
| 640 x 480 (30 fps)                    |                     | 640 x 480 (30 fps)  | 640 x 480 (30 fps) | 640 x 480 (30 fps) |                    |
|                                       |                     |                     | 352 x 240 (30 fps) | 352 x 240 (30 fps) |                    |
| 352 x 240 (30 fps)                    |                     | 352 x 240 (30 fps)  | 352 x 240 (30 fps) | 352 x 240 (30 fps) |                    |

| H.264 + H.264 + H.264 + H.264 / MJPEG |                    |                    |                    |                    |                    |
|---------------------------------------|--------------------|--------------------|--------------------|--------------------|--------------------|
| H.264-1                               | H.264-2            | H.264-3            | H.264-4 / MJPEG    |                    |                    |
| 800 x 600 (30 fps)                    | 800 x 600 (30 fps) | 800 x 600 (30 fps) | 352 x 240 (30 fps) |                    |                    |
|                                       |                    | 720 x 480 (30 fps) | 720 x 480 (30 fps) | 720 x 480 (30 fps) |                    |
|                                       |                    |                    | 640 x 480 (30 fps) | 640 x 480 (30 fps) |                    |
|                                       |                    | 720 x 480 (30 fps) | 640 x 480 (30 fps) | 640 x 480 (30 fps) | 352 x 240 (30 fps) |
|                                       | 640 x 480 (30 fps) |                    | 352 x 240 (30 fps) | 640 x 480 (30 fps) |                    |
|                                       |                    |                    | 720 x 480 (30 fps) | 640 x 480 (30 fps) |                    |
|                                       | 352 x 240 (30 fps) |                    | 352 x 240 (30 fps) | 352 x 240 (30 fps) |                    |
|                                       | 640 x 480 (30 fps) | 640 x 480 (30 fps) | 640 x 480 (30 fps) | 640 x 480 (30 fps) |                    |
|                                       |                    |                    | 352 x 240 (30 fps) | 352 x 240 (30 fps) |                    |
|                                       |                    | 352 x 240 (30 fps) | 352 x 240 (30 fps) | 352 x 240 (30 fps) | 352 x 240 (30 fps) |
|                                       |                    |                    | 352 x 240 (30 fps) | 352 x 240 (30 fps) | 352 x 240 (30 fps) |
|                                       | 720 x 480 (30 fps) | 720 x 480 (30 fps) | 720 x 480 (30 fps) | 720 x 480 (30 fps) |                    |
| 640 x 480 (30 fps)                    |                    |                    | 640 x 480 (30 fps) | 640 x 480 (30 fps) |                    |
|                                       |                    |                    | 352 x 240 (30 fps) | 352 x 240 (30 fps) |                    |
| 640 x 480 (30 fps)                    |                    | 640 x 480 (30 fps) | 640 x 480 (30 fps) | 640 x 480 (30 fps) |                    |
|                                       |                    | 352 x 240 (30 fps) | 352 x 240 (30 fps) | 352 x 240 (30 fps) |                    |
|                                       |                    | 352 x 240 (30 fps) | 352 x 240 (30 fps) | 352 x 240 (30 fps) |                    |
| 640 x 480 (30 fps)                    |                    | 640 x 480 (30 fps) | 640 x 480 (30 fps) | 640 x 480 (30 fps) |                    |
|                                       |                    |                    | 352 x 240 (30 fps) | 352 x 240 (30 fps) |                    |
|                                       | 352 x 240 (30 fps) | 352 x 240 (30 fps) | 352 x 240 (30 fps) | 352 x 240 (30 fps) |                    |
| 352 x 240 (30 fps)                    | 352 x 240 (30 fps) | 352 x 240 (30 fps) | 352 x 240 (30 fps) |                    |                    |
|                                       |                    | 352 x 240 (30 fps) | 352 x 240 (30 fps) |                    |                    |



## 2M Real time / 3M / 5M- Triple Streams

| H.264-1 + H.264-2 + H.264-3 / MJPEG |                    |                    |
|-------------------------------------|--------------------|--------------------|
| H.264-1                             | H.264-2            | H.264-3 / MJPEG    |
| 2592 x 1944 (10 fps)                | 720 x 480 (10 fps) | 720 x 480 (10 fps) |
|                                     |                    | 640 x 480 (10 fps) |
|                                     |                    | 352 x 240 (10 fps) |
|                                     | 640 x 480 (10 fps) | 640 x 480 (10 fps) |
|                                     |                    | 640 x 480 (10 fps) |
|                                     |                    | 352 x 240 (10 fps) |

\*The resolution is for 5M Model only.

| H.264-1 + H.264-2 + H.264-3 / MJPEG |                     |                    |
|-------------------------------------|---------------------|--------------------|
| H.264-1                             | H.264-2             | H.264-3 / MJPEG    |
| 2048 x 1536 (15 fps)                | 1280 x 720 (15 fps) | 720 x 480 (15 fps) |
|                                     |                     | 640 x 480 (15 fps) |
|                                     |                     | 352 x 240 (15 fps) |
|                                     | 800 x 600 (15 fps)  | 800 x 600 (15 fps) |
|                                     |                     | 720 x 480 (15 fps) |
|                                     |                     | 640 x 480 (15 fps) |
|                                     | 720 x 480 (15 fps)  | 352 x 240 (15 fps) |
|                                     |                     | 720 x 480 (15 fps) |
|                                     |                     | 640 x 480 (15 fps) |
|                                     | 640 x 480 (15 fps)  | 352 x 240 (15 fps) |
|                                     |                     | 640 x 480 (15 fps) |
|                                     |                     | 352 x 240 (15 fps) |
|                                     | 352 x 240 (15 fps)  | 352 x 240 (15 fps) |

\*The resolution is for 3M & 5M Model only.

| H.264-1 + H.264-2 + H.264-3 / MJPEG |                      |                     |
|-------------------------------------|----------------------|---------------------|
| H.264-1                             | H.264-2              | H.264-3 / MJPEG     |
| 1920 x 1080 (15 fps)                | 1280 x 1024 (15 fps) | 1280 x 720 (15 fps) |
|                                     |                      | 800 x 600 (30 fps)  |
|                                     |                      | 720 x 480 (30 fps)  |
|                                     |                      | 640 x 480 (30 fps)  |
|                                     |                      | 352 x 240 (30 fps)  |
|                                     | 1280 x 720 (15 fps)  | 1280 x 720 (30 fps) |
|                                     |                      | 800 x 600 (30 fps)  |
|                                     | 1280 x 720 (30 fps)  | 720 x 480 (30 fps)  |
|                                     |                      | 640 x 480 (30 fps)  |
|                                     |                      | 352 x 240 (30 fps)  |
|                                     | 1024 x 768 (30 fps)  | 800 x 600 (30 fps)  |
|                                     |                      | 720 x 480 (30 fps)  |
|                                     |                      | 640 x 480 (30 fps)  |
|                                     |                      | 352 x 240 (30 fps)  |
|                                     | 800 x 600 (30 fps)   | 800 x 600 (30 fps)  |
|                                     |                      | 720 x 480 (30 fps)  |
|                                     |                      | 640 x 480 (30 fps)  |
|                                     |                      | 352 x 240 (30 fps)  |
|                                     | 720 x 480 (30 fps)   | 720 x 480 (30 fps)  |
|                                     |                      | 640 x 480 (30 fps)  |
|                                     |                      | 352 x 240 (30 fps)  |
| 640 x 480 (30 fps)                  | 640 x 480 (30 fps)   |                     |
|                                     | 352 x 240 (30 fps)   |                     |
| 1920 x 1080 (30 fps)                | 352 x 240 (30 fps)   | 352 x 240 (30 fps)  |

| H.264-1 + H.264-2 + H.264-3 / MJPEG |                      |                     |
|-------------------------------------|----------------------|---------------------|
| H.264-1                             | H.264-2              | H.264-3 / MJPEG     |
| 1280 x 1024 (15 fps)                | 1280 x 1024 (15 fps) | 1280 x 720 (30 fps) |
|                                     |                      | 800 x 600 (30 fps)  |
|                                     | 1280 x 1024 (30 fps) | 720 x 480 (30 fps)  |
|                                     |                      | 640 x 480 (30 fps)  |
|                                     | 1280 x 720 (15 fps)  | 352 x 240 (30 fps)  |
|                                     | 1280 x 720 (30 fps)  | 1280 x 720 (30 fps) |
| 800 x 600 (30 fps)                  |                      |                     |
| 720 x 480 (30 fps)                  |                      |                     |
| 1024 x 768 (30 fps)                 | 640 x 480 (30 fps)   |                     |
|                                     | 352 x 240 (30 fps)   |                     |
| 1280 x 1024 (30 fps)                | 1280 x 720 (30 fps)  | 800 x 600 (30 fps)  |
|                                     | 1024 x 768 (30 fps)  | 720 x 480 (30 fps)  |
|                                     |                      | 640 x 480 (30 fps)  |
|                                     |                      | 352 x 240 (30 fps)  |
|                                     | 800 x 600 (30 fps)   | 720 x 480 (30 fps)  |
|                                     |                      | 640 x 480 (30 fps)  |
|                                     | 720 x 480 (30 fps)   | 640 x 480 (30 fps)  |
| 352 x 240 (30 fps)                  |                      |                     |
| 640 x 480 (30 fps)                  | 352 x 240 (30 fps)   |                     |
| 352 x 240 (30 fps)                  | 352 x 240 (30 fps)   |                     |
| 1280 x 720 (15 fps)                 | 1280 x 720 (30 fps)  | 1280 x 720 (30 fps) |
| 1280 x 720 (30 fps)                 | 1280 x 720 (30 fps)  | 800 x 600 (30 fps)  |
|                                     |                      | 720 x 480 (30 fps)  |
|                                     |                      | 640 x 480 (30 fps)  |
|                                     |                      | 352 x 240 (30 fps)  |
|                                     | 1024 x 768 (30 fps)  | 800 x 600 (30 fps)  |
|                                     |                      | 720 x 480 (30 fps)  |
|                                     |                      | 640 x 480 (30 fps)  |
|                                     |                      | 352 x 240 (30 fps)  |
|                                     | 800 x 600 (30 fps)   | 800 x 600 (30 fps)  |
|                                     |                      | 720 x 480 (30 fps)  |
|                                     |                      | 640 x 480 (30 fps)  |
|                                     | 720 x 480 (30 fps)   | 640 x 480 (30 fps)  |
|                                     |                      | 352 x 240 (30 fps)  |
| 640 x 480 (30 fps)                  | 640 x 480 (30 fps)   |                     |
| 352 x 240 (30 fps)                  | 352 x 240 (30 fps)   |                     |
| 1024 x 768 (30 fps)                 | 1024 x 768 (30 fps)  | 800 x 600 (30 fps)  |
|                                     |                      | 720 x 480 (30 fps)  |
|                                     |                      | 640 x 480 (30 fps)  |
|                                     |                      | 352 x 240 (30 fps)  |
|                                     | 800 x 600 (30 fps)   | 800 x 600 (30 fps)  |
|                                     |                      | 720 x 480 (30 fps)  |
|                                     |                      | 640 x 480 (30 fps)  |
|                                     | 720 x 480 (30 fps)   | 640 x 480 (30 fps)  |
|                                     |                      | 352 x 240 (30 fps)  |
|                                     | 640 x 480 (30 fps)   | 640 x 480 (30 fps)  |
| 352 x 240 (30 fps)                  | 352 x 240 (30 fps)   |                     |

| H.264-1 + H.264-2 + H.264-3 / MJPEG |                    |                    |                    |
|-------------------------------------|--------------------|--------------------|--------------------|
| H.264-1                             | H.264-2            | H.264-3 / MJPEG    |                    |
| 800 x 600 (30 fps)                  | 800 x 600 (30 fps) | 800 x 600 (30 fps) |                    |
|                                     |                    | 720 x 480 (30 fps) |                    |
|                                     |                    | 640 x 480 (30 fps) |                    |
|                                     |                    | 352 x 240 (30 fps) |                    |
|                                     | 720 x 480 (30 fps) | 720 x 480 (30 fps) | 720 x 480 (30 fps) |
|                                     |                    |                    | 640 x 480 (30 fps) |
|                                     |                    |                    | 352 x 240 (30 fps) |
|                                     |                    |                    | 352 x 240 (30 fps) |
|                                     | 640 x 480 (30 fps) | 640 x 480 (30 fps) | 640 x 480 (30 fps) |
|                                     |                    |                    | 352 x 240 (30 fps) |
|                                     |                    |                    | 352 x 240 (30 fps) |
|                                     |                    |                    | 352 x 240 (30 fps) |
| 720 x 480 (30 fps)                  | 720 x 480 (30 fps) | 720 x 480 (30 fps) |                    |
|                                     |                    | 640 x 480 (30 fps) |                    |
|                                     |                    | 352 x 240 (30 fps) |                    |
|                                     | 640 x 480 (30 fps) | 640 x 480 (30 fps) | 640 x 480 (30 fps) |
|                                     |                    |                    | 352 x 240 (30 fps) |
|                                     |                    |                    | 352 x 240 (30 fps) |
| 640 x 480 (30 fps)                  | 640 x 480 (30 fps) | 640 x 480 (30 fps) |                    |
|                                     |                    | 352 x 240 (30 fps) |                    |
|                                     |                    | 352 x 240 (30 fps) |                    |
| 352 x 240 (30 fps)                  | 352 x 240 (30 fps) | 352 x 240 (30 fps) |                    |

## 2M Real time / 3M / 5M- Dual Streams

| H.264-1 + H.264-2 / MJPEG |                    |             |
|---------------------------|--------------------|-------------|
| H.264-1                   | H.264-2 / MJPEG    | BNC SUPPORT |
| 2952 x 1944 (10 fps)      | 720 x 480 (10 fps) | -           |
|                           | 640 x 480 (10 fps) | -           |
|                           | 352 x 240 (10 fps) | -           |

\*The resolution is for 5M Model only.

| H.264-1 + H.264-2 / MJPEG |                     |             |
|---------------------------|---------------------|-------------|
| H.264-1                   | H.264-2 / MJPEG     | BNC SUPPORT |
| 2048 x 1536 (15 fps)      | 1280 x 720 (15 fps) | -           |
|                           | 800 x 600 (15 fps)  | -           |
|                           | 720 x 480 (15 fps)  | -           |
|                           | 640 x 480 (15 fps)  | -           |
|                           | 352 x 240 (15 fps)  | -           |

\*The resolution is for 3M & 5M Model only.

| H.264-1 + H.264-2 / MJPEG |                      |             |
|---------------------------|----------------------|-------------|
| H.264-1                   | H.264-2 / MJPEG      | BNC SUPPORT |
| 1920 x 1080 (15 fps)      | 1920 x 1080 (15 fps) | √           |
|                           | 1280 x 1024 (30 fps) | -           |
|                           | 1280 x 720 (30 fps)  | -           |
|                           | 1024 x 768 (30 fps)  | -           |
|                           | 800 x 600 (30 fps)   | -           |
| 1920 x 1080 (30 fps)      | 720 x 480 (30 fps)   | √           |
|                           | 640 x 480 (30 fps)   | √           |
|                           | 352 x 240 (30 fps)   | √           |
| 1280 x 1024 (30 fps)      | 1280 x 1024 (15 fps) | √           |
|                           | 1280 x 720 (30 fps)  | -           |
|                           | 1024 x 768 (30 fps)  | -           |
|                           | 800 x 600 (30 fps)   | -           |
|                           | 720 x 480 (30 fps)   | √           |
|                           | 640 x 480 (30 fps)   | √           |
| 1280 x 720 (30 fps)       | 352 x 240 (30 fps)   | √           |
|                           | 1280 x 720 (30 fps)  | √           |
|                           | 1024 x 768 (30 fps)  | -           |
|                           | 800 x 600 (30 fps)   | -           |
|                           | 720 x 480 (30 fps)   | √           |
| 1024 x 768 (30 fps)       | 640 x 480 (30 fps)   | √           |
|                           | 352 x 240 (30 fps)   | √           |
|                           | 1024 x 768 (30 fps)  | √           |
|                           | 800 x 600 (30 fps)   | -           |
|                           | 720 x 480 (30 fps)   | √           |
| 800 x 600 (30 fps)        | 640 x 480 (30 fps)   | √           |
|                           | 352 x 240 (30 fps)   | √           |
|                           | 800 x 600 (30 fps)   | √           |
|                           | 720 x 480 (30 fps)   | √           |
| 720 x 480 (30 fps)        | 640 x 480 (30 fps)   | √           |
|                           | 352 x 240 (30 fps)   | √           |
|                           | 720 x 480 (30 fps)   | √           |
| 640 x 480 (30 fps)        | 640 x 480 (30 fps)   | √           |
|                           | 352 x 240 (30 fps)   | √           |
| 352 x 240 (30 fps)        | 352 x 240 (30 fps)   | -           |

## 2M Real time / 3M / 5M- Single Stream

| H.264 Only                          | BNC SUPPORT |
|-------------------------------------|-------------|
| 2592 x 1944 (10 fps)*               | -           |
| 2048 x 1536 (15 fps)**              | -           |
| 1920 x 1080 (30 fps) Low Latency*** | -           |
| 1920 x 1080 (30 fps)                | √           |
| 1280 x 1024 (30 fps)                | √           |
| 1280 x 720 (30 fps)                 | √           |
| 1024 x 768 (30 fps)                 | √           |
| 800 x 600 (30 fps)                  | √           |
| 720 x 480 (30 fps)                  | √           |
| 640 x 480 (30 fps)                  | √           |
| 352 x 240 (30 fps)                  | -           |

\* The resolution is for 5M Model only.

\*\* The resolution is for 3M & 5M Model only.

\*\*\* 1920 x 1080 (30 fps) Low Latency does not support BNC, 3DNR, Motion Detection and digital zoom.

| MJPEG Only           | BNC SUPPORT |
|----------------------|-------------|
| 1920 x 1080 (30 fps) | √           |
| 1280 x 1024 (30 fps) | √           |
| 1280 x 720 (30 fps)  | √           |
| 1024 x 768 (30 fps)  | √           |
| 800 x 600 (30 fps)   | √           |
| 720 x 480 (30 fps)   | √           |
| 640 x 480 (30 fps)   | √           |
| 352 x 240 (30 fps)   | -           |